



PKZ and PKE motor-protective circuit-breakers

Machinery and installation downtimes should be kept as short as possible. The PKZ fuseless motor-protective circuit-breakers combine short-circuit and overload protection in one device, allowing fast restart readiness. PKZM01, PKZM0, PKZM4 and PKE have the same accessories. Combines easily with DILM contactors and DS7 soft starters. Connecting PKE to SmartWire-Darwin facilitates high data transparency.



PKZM01 (up to 16) motor-protective circuit-breaker with pushbuttons

Motor-protective circuit-breaker in housing for protection types IP40 and IP65 +++ Integrated EMERGENCY STOP and EMERGENCY OFF pushbuttons reduce wiring.

PKZM0 (up to 32 A) and PKZM4 (up to 65 A) motor-protective circuit-breakers with rotary handle

Short-circuit proof up to at least 50 kA for easy engineering +++ Trip-indicating auxiliary contact enables remote diagnosis +++ High safety through application as main switch or repair and maintenance switch +++ ATEX approval for protection of EEx e motors up to 65 A

PKE (up to 65 A) motor-protective circuit-breakers with electronic wide-range overload protection

High flexibility through plug-in trip block +++ Wide current setting ranges enable only five trip blocks up to 65 A +++ Precise and extremely long-term stable characteristic curves +++ Individual supply through integrated current converter +++ ATEX approval for protection of EEx e motors up to 65 A +++ Adjustable tripping classes

DC string circuit-breakers PKZ-SOL and DC switch-disconnectors P-SOL (up to 63 A) for installations

High string circuit-breaker flexibility due to wide current setting range +++ Enclosed switch-disconnector for external mounting (IP65) +++ Remote shutdown through optional secondary voltage and shunt trip +++ Voltage up to 1000 V DC +++ TÜV certified



Motor-protective circuit-breakers

Motor-protective circuit-breaker PKZM01, PKZM0, PKZM4, PKE

System overview

PKZM01, PKZM0, PKZM4 motor-protective circuit-breakers	7/2
--------------------------------------------------------	-----

Ordering

Motor-protective circuit-breakers	7/3
Motor-protective circuit-breakers for starter combinations	7/6
Transformer-protective circuit-breakers	7/6
PKE electronic motor-protective circuit-breaker	7/8
Auxiliary contacts	7/10
Auxiliary contacts, shunt releases	7/12

Engineering

Accessories for motor-protective circuit-breakers in enclosures	7/14
	7/15

Ordering

Insulated enclosures	7/16
Accessories	7/20
Busbar adapters	7/22
Wiring sets	7/25
Three-phase commoning links	7/26
Actuating voltages	7/28

Engineering

Motor-protective circuit-breakers	7/30
Characteristic curves	7/30
Switching capacity	7/32

Technical data

Motor-protective circuit-breakers	7/36
Auxiliary contacts	7/38

Dimensions

PKZM01, PKZM0 motor-protective circuit-breaker	7/39
Accessories	7/40
PKZM4 motor-protective circuit-breaker	7/45
Accessories	7/46

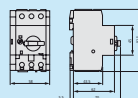
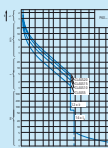
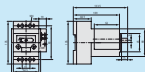
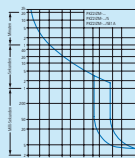
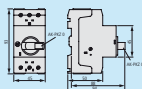
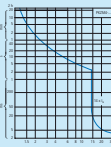
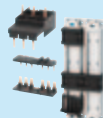

PKZ2 motor-protective circuit-breaker

System overview

PKZ2 motor-protective circuit-breakers	7/47
----------------------------------------	------

Ordering

Motor-protective circuit-breakers	7/48
Circuit-breakers	7/48
Compact starters, high-capacity compact starters	7/50
Motor protection modules	7/52
Modules for system protection	7/52
Insulated enclosures	7/56
Auxiliary contacts	7/58
Current limiters	7/58
Shunt releases	7/60
Remote operators	7/62
Contact modules	7/64
Accessories for contact modules	7/66
Accessories	7/68
Actuating voltages	7/70

Engineering

Characteristic curves	7/72
Switching capacity	7/74

Technical data

Motor-protective circuit-breakers	7/78
(High-capacity) contact modules	7/79
Current limiters	7/79
Auxiliary contacts	7/80
Shunt releases	7/80
Remote operators	7/81

Dimensions

Motor-protective circuit-breakers	7/82
Accessories	7/83

DC string circuit-breaker PKZ-SOL, DC switch-disconnectors P-SOL, SOL

Description

DC switches P-SOL, PKZ-SOL, SOL	7/84
---------------------------------	------

Ordering

DC switch-disconnector SOL, ready-to-install	7/85
DC switch-disconnector P-SOL, open	7/86
DC string circuit-breaker PKZ-SOL	7/86

Engineering

Circuit P-SOL, PKZ-SOL	7/87
Interior circuit SOL	
Characteristic curves	7/88

Technical data

DC switch-disconnectors P-SOL, SOL	7/89
DC string circuit-breaker PKZ-SOL	7/90

Dimensions

DC switches P-SOL, PKZ-SOL, SOL	7/91
---------------------------------	------



System overview

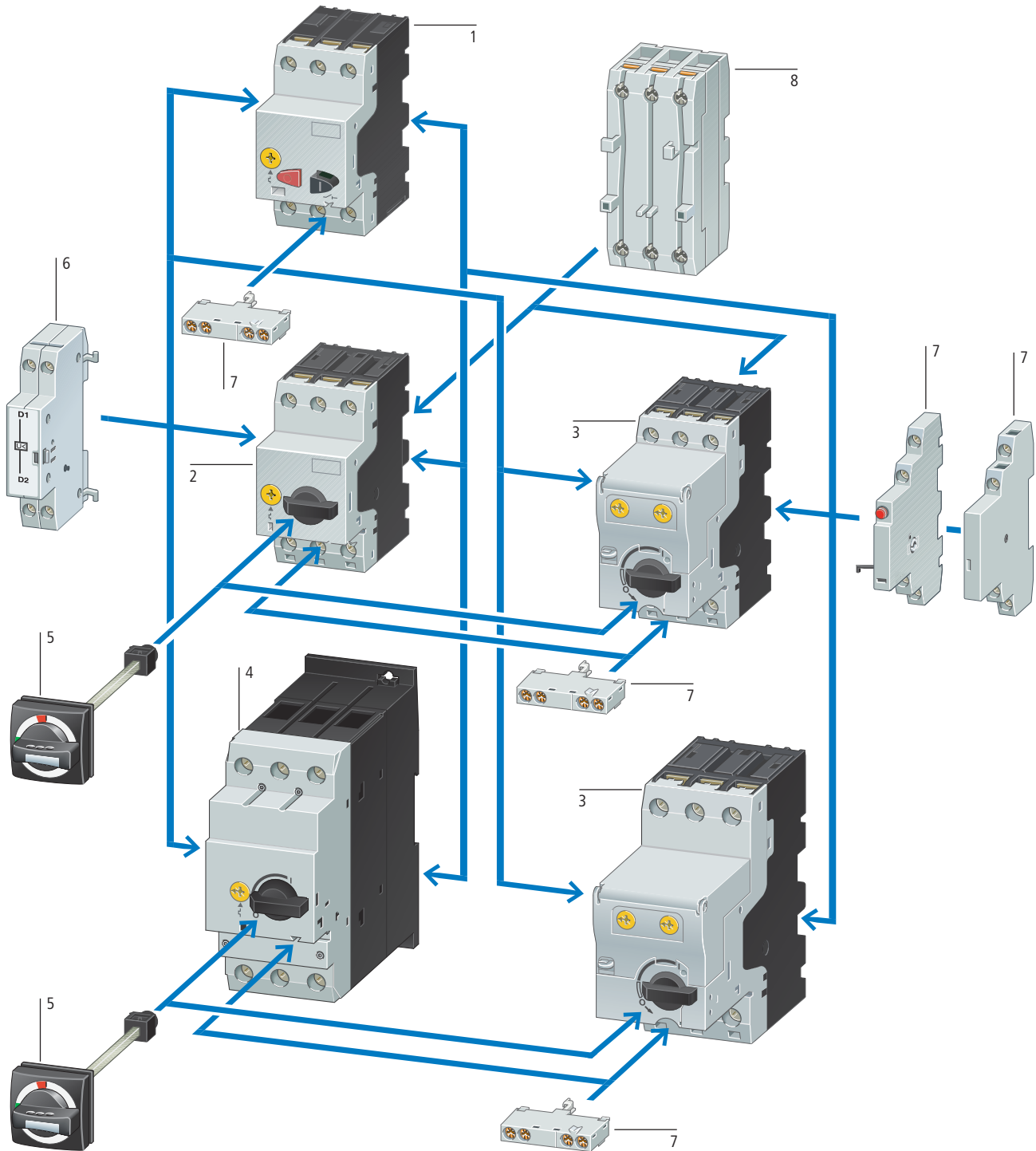

Basic devices

Motor-protective circuit-breaker PKZM01 1
→ Page 7/3

Motor-protective circuit-breaker PKZM0 2
→ Page 7/4

Motor-protective circuit-breaker with wide-range overload protection 3
→ Page 7/8

Motor-protective circuit-breaker PKZM4 4
→ Page 7/4

Add-on functions

Standard auxiliary contacts 7
→ Page 7/10

Shunt release 6
→ Page 7/29

Current limiters 8
→ Page 7/12

Mounting accessories

Door coupling handles IP65 5
→ Page 7/20

Insulated enclosure
→ Page 7/16

Mounting/wiring
→ Page 7/22

Ordering

							Screw terminals		Std. pack	Information relevant for export to North America
Max. motor rating AC-3			Rated uninterrupted current	Setting range		Part no. Article no.	Price See price list			
220 V	380 V	440 V		Overload releases	Short-circuit releases					
230 V	400 V		I_u	I_r	I_{rm}	PKZM01-0.16 278475		1 off 	Product Standards UL 508; CSA-C22.2 No. 14; IEC60947-4-1; CE marking	
240 V	415 V									
P	P	P	A	A	A	PKZM01-0.25 278476			UL File No. E36332	
kW	kW	kW				PKZM01-0.4 278477			UL CCN NLRV	
Motor-protective circuit-breakers, type "1"; and type "2" coordination									CSA File No. 12528	
	-	-	0.16	0.1...0.16	2.2	PKZM01-0.63 278478			CSA Class No. 3211-05	
	-	0.06	0.06	0.16...0.25	3.5	PKZM01-1 278479			NA Certification UL Listed, CSA certified	
	0.06	0.09	0.12	0.4	5.6	PKZM01-1.6 278480			Suitable for Branch circuit, or suitable for group installations	
	0.09	0.12	0.18	0.63	8.8	PKZM01-2.5 278481			See also → Page 7/34	
	0.12	0.25	0.25	1	14	PKZM01-4 278482				
	0.25	0.55	0.55	1.6	22	PKZM01-6.3 278483				
	0.37	0.75	1.1	2.5	35	PKZM01-10 278484				
	0.75	1.5	1.5	4	56	PKZM01-12 278485				
	1.1	2.2	3	6.3	88	PKZM01-16 283390				
	2.2	4	4	10	140	PKZM01-20 283383				
	3	5.5	5.5	12	168	PKZM01-25 288893				
	4	7.5	9	16	224					
	5.5	9	11	20	280					
	5.5	12.5	12.5	25	350					

Notes

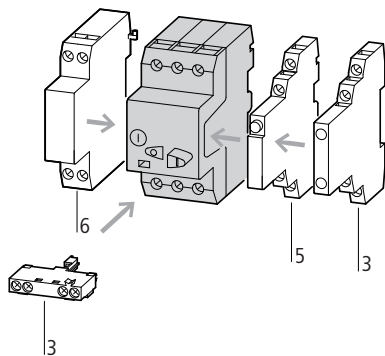

Accessories

- 3 Standard auxiliary contacts → 7/10
 - 5 Trip-indicating auxiliary contact → 7/12
 - 6 Shunt release, undervoltage release → 7/29
- Phase failure sensitivity to IEC/EN 60947-4-1, VDE 0660 Part 102.
Can be snap-fitted to IEC/EN 60715 top-hat rail with 7.5 or 15 mm height

Page

- 7/10
- 7/12
- 7/29

Circuit diagrams	Max. motor rating AC-3					Rated uninter-rupted current	Setting range		Screw terminals	Screw terminals on feed side, spring-loaded terminals on output side
	220 V 230 V 240 V	380 V 400 V 415 V	440 V	500 V	660 V 690 V		Overload releases	Short-circuit releases		
	P	P	P	P	P	I_u	I_r			
	kW	kW	kW	kW	kW	A	A			
Motor-protective circuit-breakers, type "1" and type "2" coordination¹⁾										
	-	-	-	-	0.06	0.16	0.1...0.16	2.2	PKZM0-0.16 072730	PKZM0-0.16-SC 229828
	-	0.06	0.06	0.06	0.12	0.25	0.16...0.25	3.5	PKZM0-0.25 072731	PKZM0-0.25-SC 229829
	0.06	0.09	0.12	0.12	0.18	0.4	0.25...0.4	5.6	PKZM0-0.4 072732	PKZM0-0.4-SC 229830
	0.09	0.12	0.18	0.25	0.25	0.63	0.4...0.63	8.8	PKZM0-0.63 072733	PKZM0-0.63-SC 229831
	0.12	0.25	0.25	0.37	0.55	1	0.63...1	14	PKZM0-1 072734	PKZM0-1-SC 229832
	0.25	0.55	0.55	0.75	1.1	1.6	1...1.6	22	PKZM0-1.6 072735	PKZM0-1.6-SC 229833
	0.37	0.75	1.1	1.1	1.5	2.5	1.6...2.5	35	PKZM0-2.5 072736	PKZM0-2.5-SC 229834
	0.75	1.5	1.5	2.2	3	4	2.5...4	56	PKZM0-4 072737	PKZM0-4-SC 229835
	1.1	2.2	3	3	4	6.3	4...6.3	88	PKZM0-6.3 072738	PKZM0-6.3-SC 229836
	2.2	4	4	4	7.5	10	6.3...10	140	PKZM0-10 072739	PKZM0-10-SC 229837
	3	5.5	5.5	5.5	11	12	8...12	168	PKZM0-12 278486	PKZM0-12-SC 278487
	4	7.5	9	9	12.5	16	10...16	224	PKZM0-16 046938	PKZM0-16-SC 229838
	5.5	9	11	12.5	15	20	16...20	280	PKZM0-20 046988	
	5.5	12.5	12.5	15	22	25	20...25	350	PKZM0-25 046989	
	7.5	15	15	22	30	32	25...32	448	PKZM0-32 278489	
Motor-protective circuit-breakers, type "1" and type "2" coordination¹⁾										
	4	7.5	9	9	12.5	16	10...16	224	PKZM4-16 222350	
	5.5	12.5	12.5	15	22	25	16...25	350	PKZM4-25 222352	
	7.5	15	17.5	22	22	32	25...32	448	PKZM4-32 222353	
	11	20	22	24	30	40	32...40	560	PKZM4-40 222354	
	14	25	30	30	45	50	40...50	700	PKZM4-50 222355	
	17	30	37	37	55	58	50...58	812	PKZM4-58 222394	
	18.5	34	37	45	55	65	55...65	882	PKZM4-63 222413	
Circuit-breakers²⁾										
For line and cable protection										
	-	-	-	-	-	16	10...16	224	PKZM4-16-CB 132591	
	-	-	-	-	-	25	16...25	350	PKZM4-25-CB 132592	
	-	-	-	-	-	32	25...32	448	PKZM4-32-CB 132593	

Spring-loaded terminals	Std. pack	Notes	Information relevant for export to North America	
			Part no. Article no.	Price See price list
PKZM0-0.16-C 229669	1 off			
PKZM0-0.25-C 229670				
PKZM0-0.4-C 229671				
PKZM0-0.63-C 229672				
PKZM0-1-C 229673				
PKZM0-1.6-C 229674				
PKZM0-2.5-C 229675				
PKZM0-4-C 229676				
PKZM0-6.3-C 229677				
PKZM0-10-C 229678				
PKZM0-12-C 278488				
PKZM0-16-C 229679				
Accessories				
3 Standard auxiliary contacts → 7/10				
5 Trip-indicating auxiliary contact → 7/12				
6 Shunt release, undervoltage release → 7/29				
Phase failure sensitivity to IEC/EN 60947-4-1, VDE 0660 Part 102. Can be snap-fit to IEC/EN 60715 top-hat rail with 7.5 or 15 mm height				
PTB 02 ATEX 3151, see manual → 7/21				
1) Product Standards UL 508; CSA-C22.2 No. 14; IEC60947-4-1; CE marking				
UL File No. E36332				
UL CCN NLRV				
CSA File No. 12528				
CSA Class No. 3211-05				
NA Certification UL Listed, CSA certified				
Suitable for Branch circuit: Manual type E if used with terminal, or suitable for group installations				
See also → Page 7/34				
Page				
→ 7/10				
→ 7/12				
→ 7/29				
Accessories				
3 Standard auxiliary contacts → 7/10				
5 Trip-indicating auxiliary contact → 7/12				
6 Shunt release, undervoltage release → 7/29				
Only motor-protective circuit-breaker:				
Phase failure sensitivity to IEC/EN 60947-4-1, VDE 0660 Part 102				
Can be snap-fitted to IEC/EN 60715 top-hat rail with 7.5 or 15 mm height				
PTB 02 ATEX 3153, see manual → 7/21				
2) Product Standards UL 489; CSA-C22.2 no. 5-09; IEC60947-4-1; CE marking				
NA Certification Request filed for UL and CSA				
Specially designed for NA Yes				
Suitable for Feeder and branch circuit as BCPD				
Not usable as a main switch				
Phase failure sensitivity to IEC/EN 60947-4-1, VDE 0660 Part 102.				
Switching capacity of SCCR 65 kA (480 Y/277 V) 22 kA (600 Y/347 V)				

Max. motor rating AC-3					Rated uninterrupted current I_u	Setting range		Screw terminals Part no. Article no.	Price See price list	Std. pack
220 V	380 V	440 V	500 V	660 V		Overload releases I_r	Short-circuit releases I_{rm}			
230 V	400 V			690 V						
240 V	415 V									
P	P	P	P	P	A	A	A			
kW	kW	kW	kW	kW						

Motor-protective circuit-breakers for starter combinations

Short-circuit protective breakers without overload function

Max. motor rating AC-3	Rated uninterrupted current I_u	Overload releases I_r	Short-circuit releases I_{rm}	Part no. Article no.	Price See price list	Std. pack
-	-	-	-	0.06	0.16	2.2
-	0.06	0.06	0.06	0.12	0.25	3.5
0.06	0.09	0.12	0.12	0.18	0.4	5.6
0.09	0.12	0.18	0.25	0.25	0.63	8.8
0.12	0.25	0.25	0.38	0.55	1	14
0.25	0.37	0.55	0.75	1.1	1.6	22
0.37	0.75	1.1	1.1	1.5	2.5	35
0.75	1.5	1.5	2.2	3	4	56
1.1	2.2	3	3	4	6.3	88
2.2	4	4	4	7.5	10	140
3	5.5	5.5	5.5	11	12	168
4	7.5	9	9	12.5	16	224
5.5	9	11	12.5	15	20	280
5.5	12.5	12.5	15	22	25	350
7.5	15	15	22	30	32	448

Transformer-protective circuit-breakers

Max. motor rating AC-3	Rated uninterrupted current I_u	Overload releases I_r	Short-circuit releases I_{rm}	Part no. Article no.	Price See price list	Std. pack
-	-	-	-	0.16	0.1...0.16	2.4
-	-	-	-	0.25	0.16...0.25	4.25
-	-	-	-	0.4	0.25...0.4	6.8
-	-	-	-	0.63	0.4...0.63	12
-	-	-	-	1	0.63...1	20
-	-	-	-	1.6	1...1.6	32
-	-	-	-	2.5	1.6...2.5	50
-	-	-	-	4	2.5...4	84
-	-	-	-	6.3	4...6.3	141
-	-	-	-	10	6.3...10	224
-	-	-	-	12	8...12	224
-	-	-	-	16	10...16	280
-	-	-	-	20	16...20	350
-	-	-	-	25	20...25	437

Notes

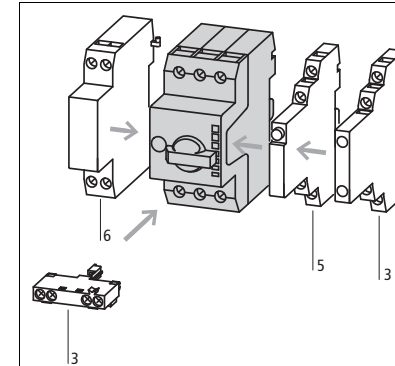

When using the PKM0 as short-circuit protection for motors with heavy starting duty, a device must be selected whose rated operational current I_n is higher by the following factors:
 CLASS 5 = 1.0
 CLASS 10 = 1.0
 CLASS 15 = 1.22
 CLASS 20 = 1.41
 CLASS 25 = 1.58
 CLASS 30 = 1.73
 CLASS 35 = 1.89
 CLASS 40 = 2.0

Accessories	Page
3 Standard auxiliary contacts	→ 7/10
5 Trip-indicating auxiliary contact	→ 7/12
6 Shunt release, undervoltage release	→ 7/29
Additional accessories	→ 2/46

Can be snap-fitted to IEC/EN 60715 top-hat rail with 7.5 or 15 mm height
 Assignment of the short-circuit protective breakers and contactors in "Fuseless motor-starter combinations" section.
 An appropriate overload relay must be fitted to protect motors against overload.

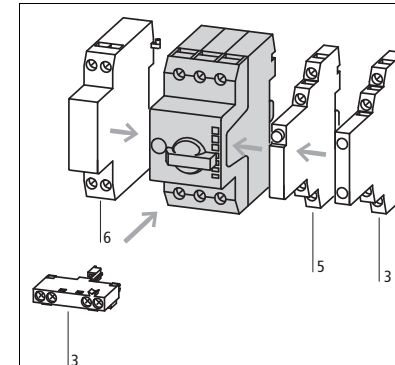













Accessories	Page
3 Standard auxiliary contacts	→ 7/10
5 Trip-indicating auxiliary contact	→ 7/12
6 Shunt release, undervoltage release	→ 7/29

For the protection of transformers with a high inrush current
 Can be snap-fitted to IEC/EN 60715 top-hat rail with 7.5 or 15 mm height
 Phase failure sensitivity to IEC/EN 60947-4-1, VDE 0660 Part 102.

Motor rating	Motor full-load current					Setting range Overload releases	Basic device		
	AC-3						Part no. Article no.	See price list	Std. pack
	220 V	380 V	440 V	500 V	660 V				
	230 V	400 V			690 V				
	240 V	415 V							
P	I	I	I	I	I				
kW	A	A	A	A	A				





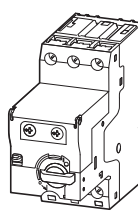
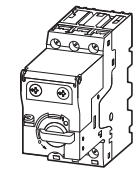



























Motor-protective circuit-breakers, type "1" and type "2" coordination

0.06	0.37	-	-	-	-	0.3...1.2 A	PKE12 121721	1off	 
0.09	0.54	0.31	-	-	-				
0.12	0.72	0.41	0.37	0.33	-				
0.18	1.04	0.6	0.54	0.48	0.35				
0.25	-	0.8	0.76	0.7	0.5				
0.37	-	1.1	1.02	0.9	0.7				
0.55	-	-	-	-	0.9				
0.75	-	-	-	-	1.1				
0.18	1.04	-	-	-	-	1...4 A	PKE12 121721	1off	 
0.25	1.4	-	-	-	-				
0.37	2	1.1	1.02	-	-				
0.55	2.7	1.5	1.39	1.2	-				
0.75	3.2	1.9	1.68	1.5	1.1				
1.1	-	2.6	2.41	2.1	1.5				
1.5	-	3.6	3.28	2.9	2.1				
2.2	-	-	-	4	2.9				
3	-	-	-	-	3.8				
0.75	3.2	-	-	-	-	3...12 A	PKE12 121721	1off	 
1.1	4.6	-	-	-	-				
1.5	6.3	3.6	3.3	-	-				
2.2	8.7	5	4.6	4	-				
3	11.5	6.6	6	5.3	3.8				
4	-	8.5	7.7	6.8	4.9				
5.5	-	11.3	10.2	9	6.5				
7.5	-	-	-	-	8.8				
2.2	8.7	-	-	-	-	8...32 A	PKE32 121722	1off	 
3	11.5	-	-	-	-				
4	14.8	8.5	-	-	-				
5.5	19.6	11.3	10.2	9	-				
7.5	26.4	15.2	13.8	12.1	8.8				
11	-	21.7	19.8	17.4	12.6				
15	-	29.3	26.6	23.4	17				
18.5	-	-	-	28.9	20.9				
22	-	-	-	-	23.8				
30	-	-	-	-	32				
5.5	19.6	-	-	-	-	16...65 A	PKE65 138258	1off	 
7.5	26.4	-	-	-	-				
11	38	21.7	19.7	17.4	-				
15	51	29.3	26.6	23.4	17				
18.5	63	36	32.9	28.9	20.9				
22	-	41	37.4	33	23.8				
30	-	55	50.3	44	32				
37	-	-	61.4	54	39				
45	-	-	-	65	47				
55	-	-	-	-	58				
2.2	8.7	-	-	-	-	8...32 A	PKE65 138258	1off	 
3	11.5	-	-	-	-				
4	14.8	8.5	-	-	-				
5.5	19.6	11.3	10.2	9	-				
7.5	26.4	15.2	13.8	12.1	8.8				
11	-	21.7	19.8	17.4	12.6				
15	-	29.3	26.6	23.4	17				
18.5	-	-	-	28.9	20.9				
22	-	-	-	-	23.8				
30	-	-	-	-	32				



Notes

Select switchgear and cables according to Class as shown in the table on page 6/22.
 1) For communications, module PKE-SWD-32 for contactors is required in addition,, → Page 1/14.

usable for	Trip module Standard			usable for	Trip module Expanded ¹⁾			Motor-protective circuit-breakers Standard Complete device		
	Part no. Article no.	See price list	Std. pack		Part no. Article no.	See price list	Std. pack	Part no. Article no.	See price list	Std. pack
PKE12	PKE-XTU-1,2 121723		1off  	PKE12	PKE-XTUA-1,2 121727		1off  	PKE12/XTU-1,2 121731		1off  
	Start of delivery 07/2010				Start of delivery 07/2010					Start of delivery 07/2010
PKE12	PKE-XTU-4 121724		1off  	PKE12	PKE-XTUA-4 121728		1off  	PKE12/XTU-4 121732		1off  
					Start of delivery 05/2010					
PKE12 PKE32	PKE-XTU-12 121725		1off  	PKE12 PKE32	PKE-XTUA-12 121729		1off  	PKE12/XTU-12 121733		1off  
					Start of delivery 05/2010					
PKE32	PKE-XTU-32 121726		1off  	PKE32	PKE-XTUA-32 121730		1off  	PKE32/XTU-32 121734		1off  
					Start of delivery 05/2010					
PKE65	PKE-XTU-65 138259		1off  	PKE65	PKE-XTUA-65 138260		1off  	PKE65/XTU-65 138516		1off
	Start of delivery 10/2010				Start of delivery 10/2010					Start of delivery 10/2010
PKE65	PKE-XTUW-32 138261		1off  	PKE65	PKE-XTUWA-32 138262		1off  	PKE65/XTUW-32 138517		1 off
	Start of delivery 10/2010				Start of delivery 10/2010					Start of delivery 10/2010



Information relevant for export to North America













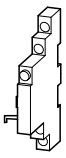
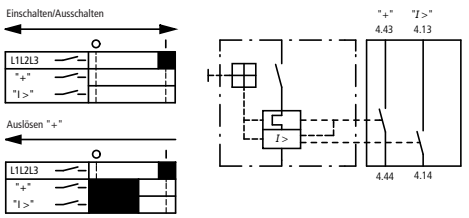

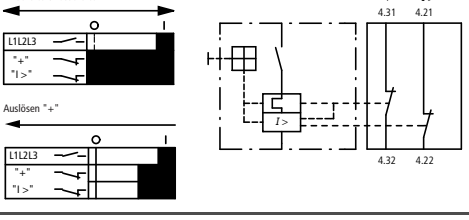

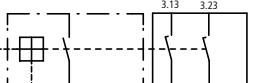

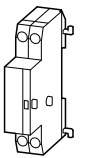

Product Standards
NA Certification

UL 508; CSA-C22.2 No. 14; IEC60947-4-1; CE marking
Request filed for UL and CSA

Contact configuration	Contact sequence	Circuit diagrams	Connection method	For use with	Part no. Article no.	Price See price list	Std. pack
1 N/O N/O = normally open contact	1 NC NC = normally closed contact		Screw terminals	PKZM01 PKZM0 PKZM4 PKZM0-T PKM0 PKE ¹⁾	NHI11-PKZ0 072896		5 off
1 N/O	1 NC		Spring-loaded terminals		NHI11-PKZ0-C 229680		
1 N/O	2 NC		Screw terminals		NHI12-PKZ0 072895		
2 N/O	1 NC		Screw terminals		NHI21-PKZ0 072894		
1 N/O	1 NC		Screw terminals		NHI-E-11-PKZ0 082882		
1 N/O	-		Screw terminals		NHI-E-10-PKZ0 082884		
1 N/O	-		Spring-loaded terminals		NHI-E-10-PKZ0-C 229681		
-	1 NC		Spring-loaded terminals		NHI-E-01-PKZ0-C 229682		5 off
1 N/O	1 NC		Screw terminals		NHI-B-11-PKZ0 208277		5 off

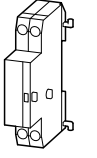
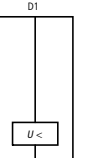
Notes ¹⁾ Only standard auxiliary contacts manufactured on or after CW 36/2009 are for use with PKE.

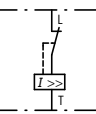
Notes	Notes	Information relevant for export to North America
<p>Can be fitted to the right side of: motor-protective circuit-breakers, transformer protective circuit breakers and motor-protective circuit-breakers for starter combinations</p> <p>Can be combined with: Trip-indicating auxiliary contact AGM, NHI-E-...</p>		<p></p> <p>Product Standards</p> <p>UL File No. E36332 UL CCN NLRV CSA File No. 12528 CSA Class No. 3211-05 NA Certification UL Listed, CSA certified</p>
<p>Can be fitted to motor-protective circuit-breakers, transformer-protective circuit-breakers and motor-protective circuit-breakers for starter combinations from serial number 01. 45 mm (PKZM0 and PKZM01) or 55 mm (PKZM4) widths of the motor-protective circuit-breakers remain unchanged. NHI-E...-PKZ0-C not for use with MSC...-type motor starter combinations.</p>	<p>Accessories</p> <p>1 Motor-protective circuit-breakers → 7/4 5 Trip-indicating auxiliary contact → 7/12 Additional accessories → 7/20</p>	

Contact configuration	Contact sequence	Circuit diagrams	For use with	Part no. Article no.	Price	Std. pack
N/O = normally open contact NC = normally closed contact					See price list	
Trip indicators						
For motor-protective circuit-breakers						
	2 x 1 N/O		PKZM0 PKZM4 PKZM0-T PKM0 PKZM01 PKE ¹⁾	AGM2-10-PKZ0 072898		2 off 
	2 x 1 NC		PKZM0 PKZM4 PKZM0-T PKM0 PKZM01 PKE ¹⁾	AGM2-01-PKZ0 072899		2 off 
Early-make auxiliary contacts						
For motor-protective circuit-breakers						
	2 N/O		PKZM0 PKZM0-T PKM0 PKZM4	VHI20-PKZ0 203595		2 off 
	2 N/O		PKZM01	VHI20-PKZ01 278495		5 off 
Shunt release (for power circuit-breakers)						
	-		PKZM0 PKZM4 PKZM0-T PKM0 PKZM01 PKE ²⁾	A-PKZ0(230V50HZ) 073187		2 off 
	-		PKZM0 PKZM4 PKZM0-T PKM0 PKZM01 PKE ²⁾	A-PKZ0(24VDC) 073200		2 off 
Undervoltage release						
	-		PKZM0 PKZM4 PKZM0-T PKM0 PKZM01 PKE ²⁾	U-PKZ0(230V50HZ) 073135		2 off 
Current limiters						
For increasing switching capacity of motor-protective circuit-breakers without auto-protection						
	-		PKZM0 PKZM4 PKE	CL-PKZ0 082881		1 off 

Notes
¹⁾ Only AGM2...-PKZ0 manufactured on or after 06/2009 can be fitted.
²⁾ Only A(U)-PKZ0... with serial number 02 or higher can be fitted.

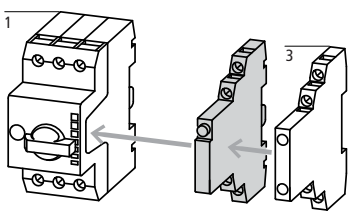
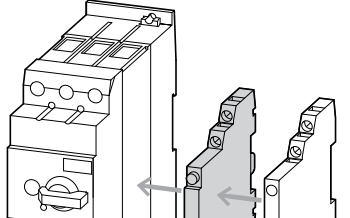
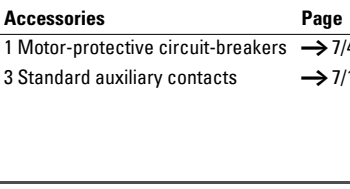
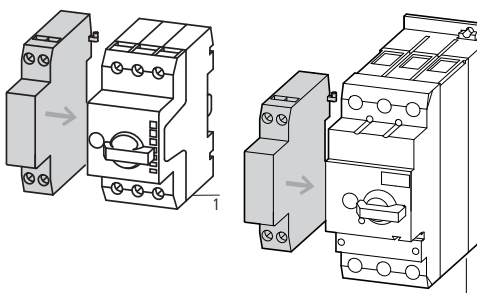
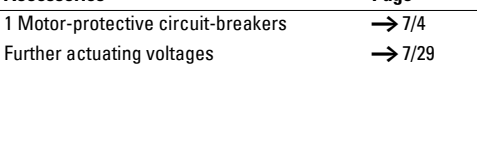
Notes	Notes	Information relevant for export to North America
		
Can be fitted to the right side of motor-protective circuit-breakers		Product Standards UL File No. E36332 UL CCN NLRV CSA File No. 12528 CSA Class No. 3211-05 NA Certification UL Listed, CSA certified
Can be combined with: Standard auxiliary contacts NHI11-PKZ0 NHI12-PKZ0 NHI21-PKZ0 NHI-E-...		
Separate indication of: a) General trip indication (overload) b) Short-circuit trip		
Local short-circuit indication by red indicator, manually resettable.		
Can be fitted to front of motor-protective circuit-breaker, 45 mm width of the motor-protective circuit-breaker remains unchanged. For early energization of undervoltage release, e.g. in emergency switching off circuits to EN 60204. VHI20-PKZ0 cannot be used in combination with PKZ0-X(R).		Accessories 1 Motor-protective circuit-breakers → 7/4 3 Standard auxiliary contacts → 7/10
Can be fitted to the left side of motor-protective circuit-breakers. Cannot be combined with: undervoltage release U-PKZ0 DC: Intermittent operation 5 s		Accessories 1 Motor-protective circuit-breakers → 7/4 Further actuating voltages → 7/29
Can be fitted to the left side of motor-protective circuit-breakers. Cannot be combined with: A-PKZ0 shunt release When combined with circuit-breaker, can be used as emergency switching off device to IEC/EN 60204.		
Max. rated operating voltage $U_e = 690$ V, rated uninterrupted current $I_u = 63$ A Can be used for individual and group protection. For group protection and in combination with PKZM4, order additional BK25/3 incoming terminal if required. Mounting next to or behind the motor-protective circuit-breaker. PKZM4: 16 - 63 A: 100 kA/400 V PKZM4: 16 - 63 A: 10 kA/690 V		

Engineering

Enclosure		Accessories									
Part no.	Part no.	Degree of protection	Handle color	NHI...-PKZ0	AGM2...-PKZ0	NHI-E...-PKZ0	VHI...-PKZ0	VHI...-PKZ01	U-PKZ0 or A-PKZ0	L-PKZ0	
Surface mounting enclosure											
Motor-protective circuit-breaker PKZM01											
	CI-PKZ01	IP40	–	–	–	●	–	–	●	●	
	CI-PKZ01-G	IP65	–	–	–	●	–	●	●	●	
	CI-PKZ01-PVT CI-PKZ01-PVS	IP65	Red-yellow	–	–	●	–	–	●	●	
	CI-PKZ01-SVB CI-PKZ01-SVB-V	IP65	–	–	–	●	–	–	●	●	
								● ¹⁾	–	●	●
Motor-protective circuit-breaker PKZM0											
	CI-K2-PKZ0	IP41	–	●	–	●	–	–	●	●	
	CI-K2-PKZ0-G	IP65	Black	–	●	●	–	–	●	●	
	CI-K2-PKZ0-GR	IP65	Red-yellow	●	–	●	–	–	●	●	
	CI-PKZ0-M	IP40	–	●	–	●	–	–	–	●	
	CI-PKZ0-GM	IP55	Black	●	–	●	–	–	–	●	
	CI-PKZ0-GRM	IP55	Red-yellow	●	–	●	–	–	–	●	
					–	–	●	–	–	●	●
Motor-protective circuit-breaker PKZM0 + early-make auxiliary contact VHI-PKZ0											
	CI-K2-PKZ0-GV	IP65	Black	●	–	–	●	–	●	●	
	CI-K2-PKZ0-GRV	IP65	Red-yellow	–	●	–	●	–	●	●	
	CI-K2-PKZ0-GVM	IP55	Black	●	–	–	●	–	–	●	
	CI-K2-PKZ0-GRVM	IP55	Red-yellow	–	–	–	●	–	●	●	
					●	–	–	●	–	–	●

Notes

The combination possibilities of circuit-breakers in an enclosure with accessory modules are identified by a ●
¹⁾ Always required



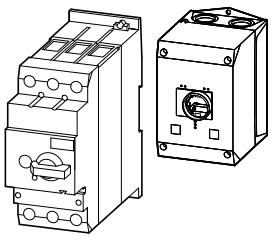
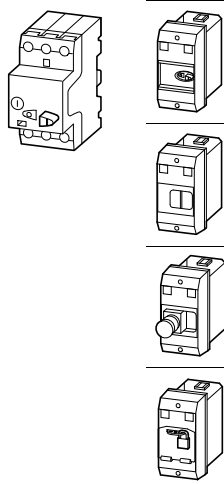
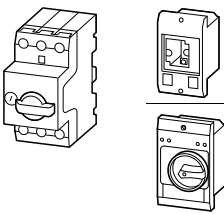







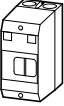

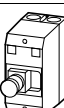

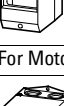
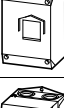
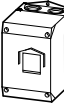
PKZM4, PKZM01, PKZM0



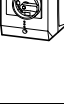



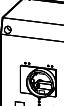
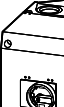





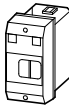





Enclosure				Accessories							
Part no.	Part no.	Degree of protection	Handle color	NHI...-PKZ0	AGM2...-PKZ0	NHI-E...-PKZ0	VHI...-PKZ0	VHI...-PKZ01	U-PKZ0 or A-PKZ0	L-PKZ0	
Surface mounting enclosure											
Motor-protective circuit-breaker PKZM4											
	CI-K4-PKZ4-G	IP65	Black	●	●	●	-	-	●	●	
	CI-K4-PKZ4-GR	IP65	Red-yellow	●	●	●	-	-	●	●	
				●	●	-	●	-	●	●	
				●	●	-	●	-	●	●	
Installation enclosure											
Motor-protective circuit-breaker PKZM01											
	E-PKZ01	IP40	-	-	-	●	-	-	●	●	
				-	-	-	-	●	●	●	
				●	-	●	-	-	-	●	
				●	-	-	-	●	-	●	
	E-PKZ01-G	IP65	-	-	-	●	-	-	●	●	
				-	-	-	-	●	●	●	
				●	-	●	-	-	-	●	
				●	-	-	-	●	-	●	
	E-PKZ01-PVT E-PKZ01-PVS	IP65	Red-yellow	-	-	●	-	-	●	●	
				-	-	-	-	●	●	●	
E-PKZ01-SVB E-PKZ01-SVB-V	IP65	-	-	-	-	●	-	●	●		
			-	-	-	-	● ¹⁾	●	●		
Motor-protective circuit-breaker PKZM0											
	E-PKZ0	IP40	-	●	-	-	-	-	-	●	
				-	-	-	-	-	●	●	
	E-PKZ0-G	IP55	Black	●	-	●	-	-	-	●	
				-	-	●	-	-	●	●	
	E-PKZ1-GR	IP55	Red-yellow	●	-	●	-	-	-	●	
			-	-	●	-	-	●	●		

Notes

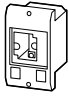



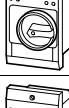







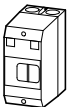





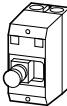

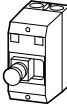
The combination possibilities of circuit-breakers in an enclosure with accessory modules are identified by a ●
¹⁾ Always required













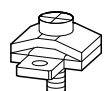

	Degree of protection	For use with	Part no. Article no.	Price See price list	Std. pack	Notes
Insulated enclosures for surface mounting						
For Motor-protective circuit-breaker PKZM01s						
	–	IP40	PKZM01 +NHI-E or VHI-PKZ01 +U or A or NHI +L (2 off)	CI-PKZ01 281403	1 off	Integrated terminal for PE(N) connection, two M25 cable entry knockouts at top and at bottom.
	With operating membrane	IP65		CI-PKZ01-G 281404		
	Lockable in Off position	IP65	PKZM01 +NHI-E or +U or A +L (2 off)	CI-PKZ01-SVB 281405		
	Lockable in Off position in combination with VHI-PKZ01	IP65		CI-PKZ01-SVB-V 281944		
	With emergency switching off mushroom button, maintained	IP65		CI-PKZ01-PVT 281406		
	With emergency switching off mushroom button, with key-release	IP65		CI-PKZ01-PVS 281407		
	For extension with inserts CI/E-PKZ01-X... unit	As insert	PKZM01	CI-PKZ01-X 289934		
For Motor-protective circuit-breakers PKZM0						
	Cover with aperture dimensioned to accommodate front of breaker. IP40, when mounted turned through 90° to left/right	IP41 with vertical mounting	PKZM0-... +NHI or AGM +U or A +NHI-E +L-PKZ0 (2 off)	CI-K2-PKZ0 219653	1 off	M25 metric cable entry knockout, top and bottom Cable push-through membrane top, bottom, in the back plate and as a control line entry. Insulated enclosure CI-K2 incl. N and PE terminal.
	With black-grey rotary knob	IP65		CI-K2-PKZ0-G 219654		
	With red-yellow rotary knob, for use as emergency switching off device to EN 60204	IP65	CI-K2-PKZ0-GR 219655			
	Cover with aperture dimensioned to accommodate front of breaker	IP40	PKZM0-... +NHI or U or A +L-PKZ0 (2 off)	CI-PKZ0-M 267083		Integrated terminal for PE(N) connection, two M25 cable entry knockouts at top and at bottom.
	With black-grey rotary knob	IP55	PKZM0-... +NHI-E +NHI or U or A +L-PKZ0 (2 off)	CI-PKZ0-GM 260089		
	With red-yellow rotary knob, for use as emergency switching off device to EN 60204	IP55		CI-PKZ0-GRM 260104		
For Motor-protective circuit-breakers PKZM0 with early-make VHI auxiliary contacts						
	With black-grey rotary knob	IP65	PKZM0-... and VHI +NHI or AGM +U or A +L (2 off)	CI-K2-PKZ0-GV 219657	1 off	M25 metric cable entry knockout, top and bottom Cable push-through membrane top, bottom, in the back plate and as a control line entry. Insulated enclosure CI-K2 incl. N and PE terminal.
	With red-yellow rotary knob, for use as emergency switching off device to EN 60204	IP65		CI-K2-PKZ0-GRV 219656		
	With black-grey rotary knob	IP55	PKZM0-... and VHI +U or A (undervoltage or shunt release) +L-PKZ0 (2 off)	CI-PKZ0-GVM 263526		
	With red-yellow rotary knob, for use as emergency switching off device to EN 60204	IP55		CI-PKZ0-GRVM 263525		
For Motor-protective circuit-breakers PKZM4						
	With black-grey rotary knob	IP65	PKZM4-... +VHI or NHI-E +NHI and AGM +U or A +L-PKZ0 (2 off)	CI-K4-PKZ4-G 225524	1 off	Metric knockout: Top and bottom: M25/M32 In the back plate: M25/M32 Control cable entry: M20 CI-K4 insulated enclosure including insulated PE terminal
	With red-yellow rotary knob, for use as emergency switching off device to EN 60204	IP65		CI-K4-PKZ4-GR 225525		

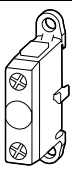









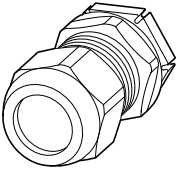
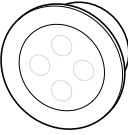





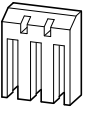









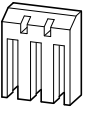



	Degree of protection	For use with	Part no. Article no.	Price See price list	Std. pack	Information relevant for export to North America 
Insulated enclosures for flush mounting						
For Motor-protective circuit-breaker PKZM01s Integrated terminal for PE(N) connection.						
	Front IP40	PKZM01 +NHI or U or A	E-PKZ01 281633		1 off 	Product Standards UL 508; CSA-C22.2 No. 14; IEC60947-4-1; CE marking E36332 NLRV UL File No. UL CCN CSA File No. 12528 CSA Class No. 3211-05 NA Certification UL Listed, CSA certified
	With operating membrane Front IP65	+NHI-E or VHI +L (2 off)	E-PKZ01-G 281634		1 off 	
	Lockable in Off position Front IP65	PKZM01 +U or A +NHI-E	E-PKZ01-SVB 281635		1 off 	
	Lockable in Off position, in combination with VHI-PKZ01 Front IP65	PKZM01 +U or A +NHI-E or VHI	E-PKZ01-SVB-V 281943		1 off 	
	With emergency switching off mushroom button, maintained Front IP65		E-PKZ01-PVT 281636		1 off 	
	With emergency switching off mushroom button, with key-release Front IP65		E-PKZ01-PVS 281637		1 off 	
	For extension with inserts Ci/E-PKZ01-X... unit As insert	PKZM01	E-PKZ01-X 289935		1 off	
For Motor-protective circuit-breakers PKZM0 Integrated terminal for PE(N) connection.						
	Cover with aperture dimensioned to accommodate front of breaker Front IP40	PKZM0-... +NHI or U or A +L-PKZ0 (2 parts)	E-PKZ0 072906		1 off 	Product Standards UL 508; CSA-C22.2 No. 14; IEC60947-4-1; CE marking E36332 NLRV UL File No. UL CCN CSA File No. 12528 CSA Class No. 3211-05 NA Certification UL Listed, CSA certified
	With black-grey rotary knob Front IP55	PKZM0-... +NHI or U or A +NHI-E +L-PKZ0 (2 parts)	E-PKZ0-G 072907		1 off 	
	With red-yellow rotary knob, for use as emergency switching off device to EN 60204 Front IP55		E-PKZ0-GR 072908		1 off 	Product Standards UL 508; CSA-C22.2 No. 14; IEC60947-4-1; CE marking E36332 NLRV UL File No. UL CCN CSA File No. 12528 CSA Class No. 3211-05 NA Certification UL Listed, CSA certified Degree of Protection IEC: Front IP55, UL/CSA Type: 1, 12, 3R

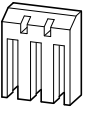

	Degree of protection	For use with	Part no. Article no.	Price See price list	Std. pack	Information relevant for export to North America 
Insulated enclosures for surface mounting						
For Motor-protective circuit-breaker PKZM01s Integrated terminal for PE(N) connection.						
	IP41	PKZM01 +NHI-E or VHI-PKZ01 +U or A or NHI +L (2 off)	CI-PKZ01-NA 281408		1 off 	Product Standards UL 508; CSA-C22.2 No. 14; IEC60947- 4-1; CE marking E36332 UL File No. NLRV UL CCN 12528 CSA File No. 3211-05 CSA Class No. 3211-05 NA Certification UL Listed, CSA certified Specially designed for NA✓ Degree of Protection IEC: IP41, UL/CSA Type: -
	With operating membrane IP65	PKZM01 +NHI-E or VHI-PKZ01 +U or A or NHI +L (2 off)	CI-PKZ01-NA-G 281409		1 off 	Product Standards UL 508; CSA-C22.2 No. 14; IEC60947- 4-1; CE marking E36332 UL File No. NLRV UL CCN 12528 CSA File No. 3211-05 CSA Class No. 3211-05 NA Certification UL Listed, CSA certified Specially designed for NA✓ Degree of Protection IEC: IP65, UL/CSA Type: -
	Lockable in Off position IP65	PKZM01 +NHI-E or VHI-PKZ01 +U or A +L (2 off)	CI-PKZ01-NA-SVB 281630		1 off 	Product Standards UL 508; CSA-C22.2 No. 14; IEC60947- 4-1; CE marking E36332 UL File No. NLRV UL CCN 12528 CSA File No. 3211-05 CSA Class No. 3211-05 NA Certification UL Listed, CSA certified Specially designed for NA✓ Degree of Protection IEC: IP65, UL/CSA Type: -
	Lockable in Off position, in combination with VHI-PKZ01 IP65	PKZM01 +NHI-E +U or A +L (2 off)	CI-PKZ01-NA-SVB-V 281945		1 off 	
	With emergency switching off mushroom button, maintained IP65		CI-PKZ01-NA-PVT 281631		1 off 	
	With emergency switching off mushroom button, with key-release IP65		CI-PKZ01-NA-PVS 281632		1 off 	
For Motor-protective circuit-breakers PKZM0 Integrated N and PE terminals; lower section without knockouts						
	With black-grey rotary knob IP55	PKZM0-... +NHI or U or A +NHI-E +L-PKZ0 (2 parts)	CI-K2-PKZ0-NA-G 262680		1 off 	Product Standards UL 508; CSA-C22.2 No. 14; IEC60947- 4-1; CE marking E36332 UL File No. NLRV UL CCN 12528 CSA File No. 3211-05 CSA Class No. 3211-05 NA Certification UL Listed, CSA certified Specially designed for NA✓ Degree of Protection IEC: IP55, UL/CSA Type: 1, 12, 3R
	With red-yellow rotary knob, for use as emergency switching off device to EN 60204 IP55		CI-K2-PKZ0-NA-GR 262681		1 off 	
For Motor-protective circuit-breakers PKZM0 with early-make auxiliary contacts Integrated N and PE terminals; lower section without knockouts						
	With black-grey rotary knob IP55	PKZM0-... +VHI... + U... +L-PKZ0 (2 parts)	CI-K2-PKZ0-NA-GV 262682		1 off 	
	With red-yellow rotary knob, for use as emergency switching off device to EN 60204 IP55		CI-K2-PKZ0-NA-GRV 262683		1 off 	

	Degree of protection	For use with	Part no. Article no.	Price See price list	Std. pack	Information relevant for export to North America 
Insulated enclosures, accessories						
Padlocking feature						
For up to 3 padlocks with 3 – 6 mm hasp thickness, for use as main switch to IEC/EN 60204						
	Lockable in the 0-position of the PKZM0 or Motor-protective circuit-breaker PKZM4.	–	CI-K2-PKZ0-G(R)(V) CI-PKZ0-G(R)(V)M	SVB-PKZ0-CI 035129	3 off 	Product Standards UL 508; CSA-C22.2 No. 14; IEC60947-4-1; CE marking E36332 UL File No. NLRV UL CCN 12528 CSA File No. 3211-05 CSA Class No. UL Listed, CSA certified NA Certification
	–	–	E-PKZ0-G(R)	SVB-PKZ0-E 035127	3 off 	
	–	–	CI-K4-PKZ4-G(R)	SVB-PKZ4-CI 225526	1 off	
Neutral terminal						
For connection of a 5th conductor						
	Flexible, 1 - 4 mm ²	–	CI-K2-PKZ0-...	K-CI-K1/2 207451	20 off 	UL/CSA certification not required
	63 A, flexible, 6 - 16 mm ²	–	CI-K4-PKZ4-G(R)	K25/1 096200	10 off	
	–	–	E-PKZ0(-G)(-GR) E-PKZ01(-G)	N-PKZ0 082160	20 off	
Units for insulated enclosures for PKZ01						
Combinable with CI-PKZ01-X and E-PKZ01-X.						
	With operating membrane	Front IP65	PKZM01 +NHI-E or VHI-PKZ01 +U or A or NHI +L (2 off)	CI/E-PKZ01-XG 289936	1 off	
	Lockable in Off position		PKZM01 +NHI-E +U or A +L (2 off)	CI/E-PKZ01-XSVB 289939		
	With emergency switching off mushroom button, maintained		PKZM01 +NHI-E or VHI-PKZ01 +U or A +L (2 off)	CI/E-PKZ01-XPVT 289937		
	With emergency switching off mushroom button, with key-release		PKZM01 +NHI-E or VHI-PKZ01 +U or A +L (2 off)	CI/E-PKZ01-XPVS 289938		
	Lockable in Off position, in combination with VHI-PKZ01		PKZM01 VHI-PKZ01 +U or A +L (2 off)	CI/E-PKZ01-XSVB-V 289980		









	Cable entry	Drilling dimensions mm	External cable diameter mm	Part no. Article no.	Price See price list	Std. pack																																																																																
Metric cable glands to EN 50262																																																																																						
<ul style="list-style-type: none"> • With lock nut and built-in strain relief • IP68 up to 5 bar, halogen free 																																																																																						
	M20	20.5	6 - 13	V-M20 206910		20 off																																																																																
	M25	25.5	9 - 17	V-M25 206911																																																																																		
	M32	32.5	13 - 21	V-M32 206912		10 off																																																																																
	M32	32.5	18 - 25	V-M32G 226156																																																																																		
Metric diaphragm grommets																																																																																						
<ul style="list-style-type: none"> • IP66 • With integral push-through diaphragm 																																																																																						
	M20	20.5	1 - 13	KT-M20 207602		100 off																																																																																
	M25	25.5	1 - 18	KT-M25 207603																																																																																		
	M32	32.5	1 - 25	KT-M32 207604																																																																																		
<table border="1"> <thead> <tr> <th></th> <th>For use with</th> <th>Part no. Article no.</th> <th>Price See price list</th> <th>Std. pack</th> <th>Notes</th> </tr> </thead> <tbody> <tr> <td colspan="6">Door coupling handles</td> </tr> <tr> <td colspan="6">Degree of protection IP65, UL/CS Type 4X / Type12</td> </tr> <tr> <td rowspan="8"></td> <td>For use as main switch to IEC/EN 60204</td> <td>Black</td> <td>PKZM0 PKZM4</td> <td>PKZ0-XH¹⁾ 106132</td> <td rowspan="4">1 off  </td> <td rowspan="8">Pluggable PKZ0-XAH extension shaft, can be cut to any required length for installation depths of 100...240 mm. Follower included in delivery. With ON/OFF switch position and "+" (tripped), lockable. With 3 padlocks, 4 – 8 mm hasp. Cannot be used in combination with VHI20-PKZ0.</td> </tr> <tr> <td>For use as a main switch with emergency switching off function to EN 60204</td> <td>Red-yellow</td> <td>PKZM0 PKZM4</td> <td>PKZ0-XRH¹⁾ 106133</td> </tr> <tr> <td>For use as a main switch to EN 60204 in MCC power distribution systems and with PKZM0 installed rotated by 90°</td> <td>Black</td> <td>PKZM0 PKZM4</td> <td>PKZ0-XH-MCC¹⁾ 106136</td> </tr> <tr> <td>For use as a main switch with emergency switching off function to EN 60204 in MCC power distribution systems and with PKZM0 installed rotated by 90°</td> <td>Red-yellow</td> <td>PKZM0 PKZM4</td> <td>PKZ0-XRH-MCC¹⁾ 106137</td> </tr> <tr> <td>For use as main switch to IEC/EN 60204</td> <td>Black</td> <td>PKE</td> <td>PKE-XH¹⁾ 142416</td> <td rowspan="4">1 off  </td> </tr> <tr> <td>For use as a main switch with emergency switching off function to EN 60204</td> <td>Red-yellow</td> <td>PKE</td> <td>PKE-XRH¹⁾ 142417</td> </tr> <tr> <td>For use as a main switch to EN 60204 in MCC power distribution systems and with PKE installed rotated by 90°</td> <td>Black</td> <td>PKE</td> <td>PKE-XH-MCC¹⁾ 142418</td> </tr> <tr> <td>For use as a main switch with emergency-switching off function to EN 60204 in MCC power distribution systems and with PKE installed rotated by 90°</td> <td>Red-yellow</td> <td>PKE</td> <td>PKE-XRH-MCC¹⁾ 142419</td> </tr> <tr> <td colspan="6">Clamp cover</td> </tr> <tr> <td rowspan="1"></td> <td>For increasing the degree of protection of the PKZM4 to IP2X</td> <td>–</td> <td>PKZM4</td> <td>HB-PKZ4²⁾ 256581</td> <td>1 off  </td> <td>Suitable for connecting cables with a max. external diameter of 9.5 mm</td> </tr> <tr> <td colspan="6">Pluggable extension shaft</td> </tr> <tr> <td>–</td> <td>–</td> <td>–</td> <td>PKZM0 PKZM4</td> <td>PKZ0-XAH¹⁾ 106134</td> <td>1 off  </td> <td>Follower not included</td> </tr> </tbody> </table>								For use with	Part no. Article no.	Price See price list	Std. pack	Notes	Door coupling handles						Degree of protection IP65, UL/CS Type 4X / Type12							For use as main switch to IEC/EN 60204	Black	PKZM0 PKZM4	PKZ0-XH¹⁾ 106132	1 off  	Pluggable PKZ0-XAH extension shaft, can be cut to any required length for installation depths of 100...240 mm. Follower included in delivery. With ON/OFF switch position and "+" (tripped), lockable. With 3 padlocks, 4 – 8 mm hasp. Cannot be used in combination with VHI20-PKZ0.	For use as a main switch with emergency switching off function to EN 60204	Red-yellow	PKZM0 PKZM4	PKZ0-XRH¹⁾ 106133	For use as a main switch to EN 60204 in MCC power distribution systems and with PKZM0 installed rotated by 90°	Black	PKZM0 PKZM4	PKZ0-XH-MCC¹⁾ 106136	For use as a main switch with emergency switching off function to EN 60204 in MCC power distribution systems and with PKZM0 installed rotated by 90°	Red-yellow	PKZM0 PKZM4	PKZ0-XRH-MCC¹⁾ 106137	For use as main switch to IEC/EN 60204	Black	PKE	PKE-XH¹⁾ 142416	1 off  	For use as a main switch with emergency switching off function to EN 60204	Red-yellow	PKE	PKE-XRH¹⁾ 142417	For use as a main switch to EN 60204 in MCC power distribution systems and with PKE installed rotated by 90°	Black	PKE	PKE-XH-MCC¹⁾ 142418	For use as a main switch with emergency-switching off function to EN 60204 in MCC power distribution systems and with PKE installed rotated by 90°	Red-yellow	PKE	PKE-XRH-MCC¹⁾ 142419	Clamp cover							For increasing the degree of protection of the PKZM4 to IP2X	–	PKZM4	HB-PKZ4²⁾ 256581	1 off  	Suitable for connecting cables with a max. external diameter of 9.5 mm	Pluggable extension shaft						–	–	–	PKZM0 PKZM4	PKZ0-XAH¹⁾ 106134	1 off  	Follower not included
	For use with	Part no. Article no.	Price See price list	Std. pack	Notes																																																																																	
Door coupling handles																																																																																						
Degree of protection IP65, UL/CS Type 4X / Type12																																																																																						
	For use as main switch to IEC/EN 60204	Black	PKZM0 PKZM4	PKZ0-XH¹⁾ 106132	1 off  	Pluggable PKZ0-XAH extension shaft, can be cut to any required length for installation depths of 100...240 mm. Follower included in delivery. With ON/OFF switch position and "+" (tripped), lockable. With 3 padlocks, 4 – 8 mm hasp. Cannot be used in combination with VHI20-PKZ0.																																																																																
	For use as a main switch with emergency switching off function to EN 60204	Red-yellow	PKZM0 PKZM4	PKZ0-XRH¹⁾ 106133																																																																																		
	For use as a main switch to EN 60204 in MCC power distribution systems and with PKZM0 installed rotated by 90°	Black	PKZM0 PKZM4	PKZ0-XH-MCC¹⁾ 106136																																																																																		
	For use as a main switch with emergency switching off function to EN 60204 in MCC power distribution systems and with PKZM0 installed rotated by 90°	Red-yellow	PKZM0 PKZM4	PKZ0-XRH-MCC¹⁾ 106137																																																																																		
	For use as main switch to IEC/EN 60204	Black	PKE	PKE-XH¹⁾ 142416	1 off  																																																																																	
	For use as a main switch with emergency switching off function to EN 60204	Red-yellow	PKE	PKE-XRH¹⁾ 142417																																																																																		
	For use as a main switch to EN 60204 in MCC power distribution systems and with PKE installed rotated by 90°	Black	PKE	PKE-XH-MCC¹⁾ 142418																																																																																		
	For use as a main switch with emergency-switching off function to EN 60204 in MCC power distribution systems and with PKE installed rotated by 90°	Red-yellow	PKE	PKE-XRH-MCC¹⁾ 142419																																																																																		
Clamp cover																																																																																						
	For increasing the degree of protection of the PKZM4 to IP2X	–	PKZM4	HB-PKZ4²⁾ 256581	1 off  	Suitable for connecting cables with a max. external diameter of 9.5 mm																																																																																
Pluggable extension shaft																																																																																						
–	–	–	PKZM0 PKZM4	PKZ0-XAH¹⁾ 106134	1 off  	Follower not included																																																																																



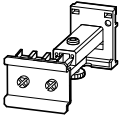







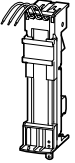

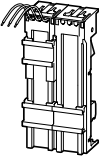
Information relevant for export to North America  

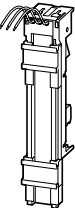
1) Product Standards	UL 508; CSA-C22.2 No. 14; IEC60947-4-1; CE marking
UL File No.	E36332
UL CCN	NLRV
CSA File No.	12528
CSA Class No.	3211-05
NA Certification	UL Listed, CSA certified
Degree of Protection	IEC: IP65, UL/CSA Type: 4X, 12

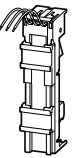

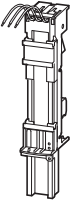
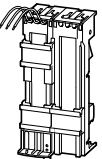





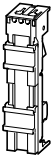

2) Product Standards	UL 508; CSA-C22.2 No. 14; IEC60947-4-1; CE marking
UL File No.	E36332
UL CCN	NLRV
CSA File No.	12528
CSA Class No.	3211-06
NA Certification	UL Listed, CSA certified

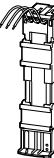
HPL07021EN

Notes		Part no. Article no.	Price See price list	Std. pack	Information relevant for export to North America 	
Telescopic adapters						
With 45 mm top-hat rail to IEC/EN 60715 for compensation of the mounting depth of rear-mounted devices enclosures CI-K and cabinets						
	Telescopic clip	Stepless adjustment via scale from 75 – 115 mm.	M22-TA 226161	1 off 	Product Standards IEC/EN 60947-5; UL 508; CSA-C22.2 No. 14-05; CSA-C22.2 No. 94-91; CE marking E29184 UL File No. E29184 UL CCN NKCR CSA File No. 012528 CSA Class No. 3211-03 NA Certification UL Listed, CSA certified	
Lockable rotary handle						
	For locking motor-protective circuit-breakers PKZM0, PKZM4 and PKE as a main switch in compliance with EN 60204. Can be padlocked in the "0" position. Hasp thickness: 3 – 6.35 mm	Can not be combined with VHI-PKZ0.	AK-PKZ0 030851	5 off 	Product Standards UL 508; CSA-C22.2 No. 14; IEC60947-4-1; CE marking E36332 UL File No. NLRV UL CCN 12528 CSA File No. 3211-05 CSA Class No. UL Listed, CSA certified NA Certification	
Holding facility						
	To prevent tampering with the overload release and the test function, it can be sealed using industry standard sealing wire For use with motor-protective circuit-breakers PKZM0 and PKZM4	–	PL-PKZ0 203599	5 off		
Mounting angle bracket						
	For screw fixing to mounting plate	–	PKE32-XMB 134837	20 off 	Product Standards UL 508; CSA-C22.2 No. 14; IEC60947-4-1; CE marking Request filed for UL and CSA NA Certification	
Documentation						
	Motor-protective circuit-breakers PKZM0, overload monitoring of EEx e motors	German/English	AWB1210-1458D/GB 266164	1 off		
	Motor-protective circuit-breakers PKZM4, overload monitoring of EEx e motors	German/English	AWB1210-1457D/GB 266165			
	Motor-protective circuit-breakers PKE, EEx electric motor overload monitoring	German/English	AWB1210-1631DE/EN 134836			
	For use with	Color	Voltage U_s V	Part no. Article no.	Price See price list	Std. pack
Indicator lights with glow lamp						
	CI-K2-PKZ0-..., CI-K4-PKZ4, CI-PKZ0(1), E-PKZ0(1)	White	110 - 230	L-PKZ0(230V) 082151		10 off
	CI-K2-PKZ0-..., CI-K4-PKZ4, CI-PKZ0(1), E-PKZ0(1)	White	230 - 400	L-PKZ0(400V) 082152		10 off
	CI-K2-PKZ0-..., CI-K4-PKZ4, CI-PKZ0(1), E-PKZ0(1)	White	415 - 500	L-PKZ0(500V) 082153		5 off
	CI-K2-PKZ0-..., CI-K4-PKZ4, CI-PKZ0(1), E-PKZ0(1)	Green	110 - 230	L-PKZ0-GN(230V) 082154		10 off
	CI-K2-PKZ0-..., CI-K4-PKZ4, CI-PKZ0(1), E-PKZ0(1)	Green	230 - 400	L-PKZ0-GN(400V) 082155		10 off
	CI-K2-PKZ0-..., CI-K4-PKZ4, CI-PKZ0(1), E-PKZ0(1)	Green	415 - 500	L-PKZ0-GN(500V) 082156		5 off
	CI-K2-PKZ0-..., CI-K4-PKZ4, CI-PKZ0(1), E-PKZ0(1)	Red	110 - 230	L-PKZ0-RT(230V) 082157		10 off
	CI-K2-PKZ0-..., CI-K4-PKZ4, CI-PKZ0(1), E-PKZ0(1)	Red	230 - 400	L-PKZ0-RT(400V) 082158		10 off

	Rated operational voltage U_e V	Conductor cross-section	Adapter width mm	Mounting rails Number	For use with	Part no. Article no.	Price See price list	Std. pack	Notes	
Busbar adapters for PKZ and PKE										
Approved to UL 508. For fitting to flat copper busbars with 60 mm between busbar centers, suitable for 5 mm and 10 mm busbar thickness.										
Rated operational current 16 A										
For starters with spring-loaded terminals										
	690	AWG 14 (2.5 mm ²)	45	2	PKZM0-C + DILMC7 PKZM0-C + DILMC9 PKZM0-C + DILMC12	BBA0C-16 101455		4 off  	According to UL 508: $I_e = 12 A$	
Rated operational current 25 A										
For reversing starters										
	690	AWG 12 (4 mm ²)	90	1	PKZM0, PKE + 2 x DILM7-01 PKZM0, PKE + 2 x DILM9-01 PKZM0, PKE + 2 x DILM12-01 MSC-R-0,25-M7... - MSC-R-12-M12...	BBA0R-25 101453		2 off  	In combination with individual components PKZM0 and DILM, use reversing starter kit PKZM0-XRM12. Fully assembled and tested combination with MSC-R → Page 8/20 Only busbar adapters/wiring sets manufactured on or after CW35/2009 can be used for PKE.	
Can be used universally										
	690	AWG 12 (4 mm ²)	45	2	–	BBA0-25/2TS 101481		4 off  	Mounting rails can be moved within 1.25 mm grid.	
For DOL starters										
	690	AWG 12 (4 mm ²)	45	1	PKZM0, PKE + 2 x DILM17-01 PKZM0, PKE + 2 x DILM25-01 PKZM0, PKE + 2 x DILM25-01 PKZM0, PKE + 2 x DILM32-01 MSC-R-16-M17... MSC-R-32-M32...	BBA0-25 101451		4 off  	In combination with individual components PKZM0 and DILM, use DOL starter kit PKZM0-XRM12. Fully assembled and tested combination with MSC-D → Page 8/2 Only busbar adapters/wiring sets manufactured on or after CW35/2009 can be used for PKE.	
For soft starters										
	690	AWG 12 (4 mm ²)	45	1	PKZM0, PKE + DS7...004N... PKZM0, PKE + DS7...007N... PKZM0, PKE + DS7...009N... PKZM0, PKE + DS7...012N...	BBA0L-25 142526		1 off	–	
Rated operational current 32 A										
For reversing starters										
	690	AWG 10 (6 mm ²)	90	3	PKZM0, PKE + 2 x DILM17-01 PKZM0, PKE + 2 x DILM25-01 PKZM0, PKE + 2 x DILM32-01 MSC-R-16-M17... - MSC-R-32-M32...	BBA0R-32 101454		2 off  	In combination with single components PKZM0 and DILM, wiring kit PKZM0-XM32DE and reversing starter wiring kit DILM32-XRL can be used. Fully assembled and tested combination with MSC-R → Page 8/20 Only busbar adapters/wiring sets manufactured on or after CW35/2009 can be used for PKE.	
Information relevant for export to North America  					Product Standards	UL 508A; CSA-C22.2 No. 14; IEC60439-1; CE marking	CSA File No. CSA Class No. NA Certification Max. Voltage Rating	232140 3211-37 UL Listed, CSA certified 600 V AC		
					UL File No.	E300273				
					UL CCN	NMTR, NMTRZ				

HPL07023EN











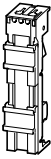





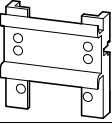

	Rated operational voltage U_e V	Conductor cross-section	Adapter width mm	Mounting rails Number	For use with	Part no. Article no.	Price See price list	Std. pack	Notes
Rated operational current 32 A									
Can be used universally.									
	690	–	45	2	PKZM0..., PKE + DILM...	BBA0-32/2TS-C²⁾ 116708		4 off 	Universal adapter 1-, 2- and 3-phase applications. Mounting rail can be moved within 1.25 mm grid. For conductor cross-sections, round conductors of up to 6 mm ² . Only busbar adapters/wiring sets manufactured on or after CW 35/2009 can be used for PKE.
For DOL starters.									
	690	AWG 10 (6 mm ²)	45	2	PKZM0, PKE + DILM17 PKZM0, PKE + DILM25 PKZM0, PKE + DILM32 MSC-D-16-M17... - MSC-D-32-M32...	BBA0-32¹⁾ 101452		4 off 	In combination with individual components PKZM0 and DILM wiring kit PKZM0-XM32DE can be used. Fully assembled and tested combination with MSC-D → Page 8/2 Only busbar adapters/wiring sets manufactured on or after CW35/2009 can be used for PKE.
For soft starters									
	690	AWG 10 (6 mm ²)	45	2	PKZM0, PKE + DS7...016N... PKZM0, PKE + DS7...024N... PKZM0, PKE + DS7...032N...	BBA0L-32 142527		1 off	–
For 160 mm adapter system with motor-protective circuit-breakers									
–	690	AWG 10 (6 mm ²)	45	1	PKZM0, PKE	BBA0K-32 142528		1 off	–
Rated operational current 63 A									
For DOL starters.									
	690	AWG 8 (10 mm ²)	55	2	PKZM4 + DILM17 PKZM4 + DILM25 PKZM4 + DILM32 PKZM4 + DILM40 PKZM4 + DILM50 PKZM4 + DILM65	BBA4L-63¹⁾ 101459		4 off 	The following can be used to establish an electrical connection: For PKZM4 + DILM17 to DILM32: MVS-LB0-0M-G For PKZM4 + DILM40 to DILM65: PKZM4-XM65DE.
	690	AWG 8 (10 mm ²)	72	2	PKZ2 + DILM7 PKZ2 + DILM9 PKZ2 + DILM12 PKZ2 + DILM15 PKZ2 + DILM17 PKZ2 + DILM25 PKZ2 + DILM32 PKZ2 + DILM40	BBA2L-63¹⁾ 101480		4 off 	The following can be used to establish an electrical connection: For PKZ2 + DILM7 to DILM12: MVS-LB0-00M-G For PKZ2 + DILM15 to DILM32: MVS-LB0-0M-G.
For motor-protective circuit-breakers									
	690	AWG 8 (10 mm ²)	54	1	PKZM4	BBA4-63¹⁾ 101457		4 off 	–
	690	AWG 8 (10 mm ²)	72	1	PKZ2	BBA2-63¹⁾ 101458		4 off 	–

Information relevant for export to North America

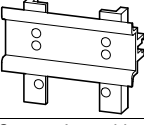

1)	
Product Standards	UL 508A; CSA-C22.2 No. 14; IEC60439-1; CE marking
UL File No.	E300273
UL CCN	NMTR, NMTR7
CSA File No.	232140
CSA Class No.	3211-37
NA Certification	UL Listed, CSA certified
Max. Voltage Rating	600 V AC

2)	
Product Standards	UL 508A; CSA-C22.2 No. 14; IEC60439-1; CE marking
UL File No.	E300273
UL CCN	NMTR, NMTR7
NA Certification	UL Listed, CSA certified
Max. Voltage Rating	600 V AC













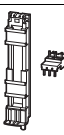

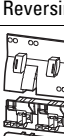





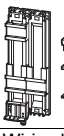

	Rated operational voltage U_e V	Conductor cross-section	Adapter width mm	Mounting rails Number	For use with	Part no. Article no.	Price See price list	Std. pack	Notes
Without electrical contacts									
Empty module.									
	-	-	45	2	-	BBA0/2TS-L¹⁾ 101482		4 off  	Mounting rails can be moved within a 1.25 mm grid. Can be used to mount reversing and star-delta starters.
	-	-	54	2	-	BBA4/2TS-L¹⁾ 101483		4 off  	Mounting rails can be moved within a 1.25 mm grid. Can be used to mount reversing and star-delta starters.
Side-mounted module, can be attached on both sides.									
	-	-	9	-	-	BBA-XSM¹⁾ 101484		10 off  	Can be grouped with busbar adapters in order to extend the mounting width.
Busbar adapters accessories									
Mounting rails									
	-	-	45	-	BBA...	PKZM0-XMR²⁾ 239364		10 off  	-
	-	-	54	-	BBA...	PKZM0-XMR5⁴⁾ 113911		10 off  	-
	-	-	72	-	BBA...	PKZM0-XMR7²⁾ 113912		10 off  	-
Connecting cable									
-	-	-	-	-	BBA...	BBA-XLT-6-130³⁾ 116902		30 off  	-
-	-	-	-	-	BBA...	BBA-XLT-16-142³⁾ 116903		30 off  	-

Information relevant for export to North America

1)	
Product Standards	UL 508A; CSA-C22.2 No. 14; IEC60439-1; CE marking
UL File No.	E300273
UL CCN	NMTR, NMTR7
CSA File No.	232140
CSA Class No.	3211-37
NA Certification	UL Listed, CSA certified
Max. Voltage Rating	600 V AC

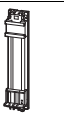
2)	
Product Standards	UL 508; CSA-C22.2 No. 14; IEC60947-4-1; CE marking
UL File No.	E300273
UL CCN	NMTR, NMTR7
CSA File No.	232140
CSA Class No.	3211-37
NA Certification	UL Listed, CSA certified

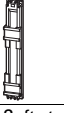
3)	
Product Standards	UL 508A; CSA-C22.2 No. 14; IEC60439-1; CE marking
UL File No.	On request
UL CCN	On request
CSA File No.	On request
CSA Class No.	On request
NA Certification	UL Recognized, CSA certified

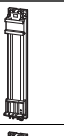
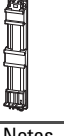
For use with	Part no. Article no.	Price See price list	Std. pack	Notes
Wiring set				
DOL starter				
	PKZM0, PKE + DILM7 PKZM0, PKE + DILM9 PKZM0, PKE + DILM12 PKZM0, PKE + DILM15 DS7-34...SX004... DS7-34...SX007... DS7-34...SX009... DS7-34...SX012...	PKZM0-XDM12 283149	1 off  	Consists of: • Mechanical connection element for PKZM0 and contactor • Main supply wiring between PKZM0 and contactor with tool-less plug connection • Cable routing As auxiliary contact, use DILA-XHIT... → Page 5/40 Cannot be combined with NHI-E...PKZ0-C. $U_e \leq 415 \text{ V}^{1)}$
	PKZM0, PKE + DILM17 PKZM0, PKE + DILM25 PKZM0, PKE + DILM32	PKZM0-XDM32 283153	1 off  	Consists of: • Top-hat rail adapter plates • Power supply wiring between PKZ and contactor ¹⁾
	PKZM4 + DILM40 PKZM4 + DILM50 PKZM4 + DILM65	PKZM4-XDM65 101053	1 off  	
Reversing starters				
	PKZM0, PKE + DILM7-01 PKZM0, PKE + DILM9-01 PKZM0, PKE + DILM12-01	PKZM0-XRM12 283185	1 off  	Consists of: • Mechanical connection element for PKZM0 and contactor • Reversing starters main supply wiring with tool-less plug connection • Control cables for electrical interlocking in tool-less plug connection: – K1M: A1 -K2M: 21 – K1M: 21 -K2M: A1 – K1M: A2 -K2M: A2 • Cable routing As auxiliary contact DILA-XHIT...use → Page 5/40 Can not be combined with AGM-PKZ0. $U_e \leq 415 \text{ V}^{1)}$
	PKZM0, PKE + DILM17 PKZM0, PKE + DILM25 PKZM0, PKE + DILM32	PKZM0-XRM32 283189	1 off  	Consists of: • Top-hat rail adapter plates • Reversing starters supply wiring ¹⁾
Wiring kit				
	PKZM0, PKE + DILM17 PKZM0, PKE + DILM25 PKZM0, PKE + DILM32 DS7-34...SX016... DS7-34...SX024... DS7-34...SX032...	PKZM0-XM32DE 239349	5 off  	• Main supply wiring between PKZM0 and contactor • Use only in combination with busbar adapter or mounting rail adapter plate
	PKZM4 + DILM40 PKZM4 + DILM50 PKZM4 + DILM65	PKZM4-XM65DE 101056	5 off  	• Main current supply between PKZM4 and contactor
Top-hat rail adapter plates				
	PKZM0-XDM12 PKZM0-XRM12	PKZM0-XC45 283132	4 off  	Consists of: • 45 mm wide adapter plate • Connection element for side-by-side positioning of further plates ¹⁾
	PKZM4 + DILM40 PKZM4 + DILM50 PKZM4 + DILM65	PKZM4-XC55/2 101054	4 off  	Consists of: • 55 mm wide adapter plate • Connection cam for additional plates • For use with reversing and start-delta starters ¹⁾
Soft starters				
	PKZM0, PKE + DS7...004N... PKZM0, PKE + DS7...007N... PKZM0, PKE + DS7...009N... PKZM0, PKE + DS7...012N...	PKZM0-XC45L 142529	1 off	Consists of: • 45 mm wide adapter plate
	PKZM0, PKE + DS7...016N... PKZM0, PKE + DS7...024N... PKZM0, PKE + DS7...032N...	PKZM0-XC45L/2 142570	1 off	Consists of: • 45 mm wide adapter plate

Notes







¹⁾ Use only busbar adapters/wiring sets manufactured on or after CW35/2009 for PKE.



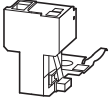

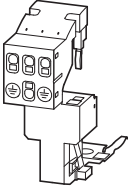

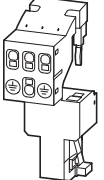







Information relevant for export to North America  

²⁾
Product Standards UL 508; CSA-C22.2 No. 14; IEC60947-4-1;
CE marking
UL File No. E36332
UL CCN NLRV
CSA File No. 12528
CSA Class No. 3211-05
NA Certification UL Listed, CSA certified

³⁾
UL/CSA certification not required

⁴⁾
Product Standards UL 508; CSA-C22.2 No. 14; IEC60947-4-1;
CE marking
UL File No. E300273
UL CCN NMTR
CSA File No. 232140
CSA Class No. 3211-37
NA Certification UL Listed, CSA certified









Description	For use with	Part no. Article no.	Price See price list	Std. pack	Notes	Information relevant for export to North America
Motor feeder plug						
PE module with contact plate						
	DILM(C)7 DILM(C)9 DILM(C)12 DILM(C)15	DILM12-XMCE 121764		5 off 	35 x 7.5 (15) mm mounting rail (as per DIN EN 60715) with PE function required. For connection of: PE 0.75 – 4 mm ²	Product Standards UL 508; CSA-C22.2 No. 14; IEC60947-4-1; CE marking NA Certification Request filed for UL and CSA
Motor feeder plug with PE module and contact plate						
	DILM(C)7 DILM(C)9 DILM(C)12 DILM(C)15	DILM12-XMCP/E 121769		1 off 	35 x 7.5 (15) mm mounting rail (as per DIN EN 60715) with PE function required. For connection of: L1, L2, L3, PE 0.75 – 2.5 mm ²	Product Standards IEC/EN 60947-4-1; UL 508; CSA-C22.2 No. 14-05; CE marking NA Certification Request filed for UL and CSA
Motor feeder plug with PE module without contact plate						
	PKZM0/PKE + DILM(C)7 PKZM0/PKE + DILM(C)9 PKZM0/PKE + DILM(C)12 PKZM0/PKE + DILM(C)15 MSC-D(E)-...-M7... MSC-D(E)-...-M9... MSC-D(E)-...-M15...	DILM12-XMCP/T 121770		1 off 	For connection of: L1, L2, L3, PE 0.75 – 2.5 mm ²	Product Standards IEC/EN 60947-4-1; UL 508; CSA-C22.2 No. 14-05; CE marking NA Certification Request filed for UL and CSA

Circuit-breakers Number	Length mm	Unit width mm	Part no. Article no.	Price See price list	Std. pack	Notes
Three-phase commoning links, incoming unit via terminals 1, 3, and 5						
Finger- and back-of-hand-proof, short-circuit proof, U _e =690 V, I _u =63 A Can be extended through rotated installation						
For PKZM0-... or PKE without side-mounted auxiliary contacts or voltage releases						
	2	90	45	B3.0/2-PKZO¹⁾ 063961	10 off 	For parallel feeding of multiple motor-protective circuit-breakers on terminals 1, 3, and 5
	3	135	45	B3.0/3-PKZO¹⁾ 232289		
	4	180	45	B3.0/4-PKZO¹⁾ 063960		
	5	225	45	B3.0/5-PKZO¹⁾ 232290		
For motor-protective circuit-breakers with one auxiliary contact or trip-indicating auxiliary contact each fitted to right side						
	2	99	45 + 9	B3.1/2-PKZO¹⁾ 044945	10 off 	For parallel feeding of multiple motor-protective circuit-breakers on terminals 1, 3, and 5
	3	153	45 + 9	B3.1/3-PKZO¹⁾ 044946		
	4	207	45 + 9	B3.1/4-PKZO¹⁾ 044947		
	5	261	45 + 9	B3.1/5-PKZO¹⁾ 044948		
For PKZM0-... or PKE with one auxiliary contact or trip-indicating auxiliary contact each fitted to right side, or one voltage release fitted on left side						
	2	108	45 + 18	B3.2/2-PKZO¹⁾ 063963	10 off 	For parallel feeding of multiple motor-protective circuit-breakers on terminals 1, 3, and 5
	4	234	45 + 18	B3.2/4-PKZO¹⁾ 063959	10 off 	

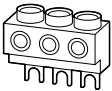
Information relevant for export to North America

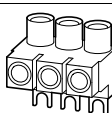

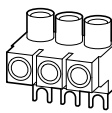





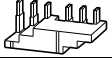

1)
Product Standards UL 508; CSA-C22.2 No. 14; IEC60947-4-1; CE marking
UL File No. E36332
UL CCN NLRV
CSA File No. 98494
CSA Class No. 3211-06
NA Certification UL Listed, CSA certified

Circuit-breakers	For use with	Unit width	Part no. Article no.	Price See price list	Std. pack	Notes
Number		mm				
Shroud for unused terminals						
Protection against direct contact. For covering unused terminals on three-phase commoning link B3...-PKZO						
	-	-	H-B3-PKZO¹⁾ 032721		20 off  	-
Incoming terminals						
	-	PKZM0 PKE	BK25/3-PKZO²⁾ 032720		5 off  	For three-phase commoning link, protected against accidental contact, $U_g = 690\text{ V}$, $I_u = 63\text{ A}$ For conductor cross-sections: 2.5 - 25 mm ² stranded 2.5 - 16 mm ² flexible with ferrule AWG 14 - 6, usable on terminals 1, 3, and 5
	-	PKZM0	BK25/3-PKZO-E³⁾ 262518		5 off  	For three-phase commoning link, protected against accidental contact, $U_g = 690\text{ V}$, $I_u = 60\text{ A}$ For conductor cross-sections: 2.5 - 25 mm ² stranded 2.5 - 16 mm ² flexible with ferrule AWG 14 - 6 For assembly of Type E starters.
	-	PKZM4	BK50/3-PKZ4-E⁴⁾ 272165		1 off  	Can be combined with three-phase commoning link B3...PKZ4. $I_u = 120\text{ A}$. For assembly of Type E starters.

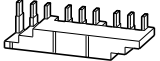
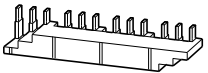
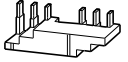

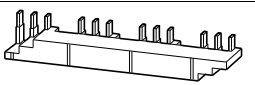
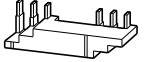

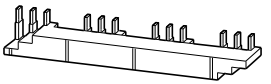



















































Information relevant for export to North America



1)	Product Standards	UL 508; CSA-C22.2 No. 14; IEC60947-4-1; CE marking	2)	Product Standards	UL 508; CSA-C22.2 No. 14; IEC60947-4-1; CE marking
	UL File No.	E36332		UL File No.	E36332
	UL CCN	NLRV		UL CCN	NLRV
	CSA File No.	98494		CSA File No.	12528
	CSA Class No.	3211-06		CSA Class No.	3211-05
	NA Certification	UL Listed, CSA certified		NA Certification	UL Listed, CSA certified
3)	Product Standards	UL 508; CSA-C22.2 No. 14; IEC60947-4-1; CE marking	4)	Product Standards	UL 508; CSA-C22.2 No. 14; IEC60947-4-1; CE marking
	UL File No.	E36332		UL File No.	E36332
	UL CCN	NLRV		UL CCN	NLRV
	CSA File No.	98494		CSA File No.	12528
	CSA Class No.	3211-06		CSA Class No.	3211-06
	NA Certification	UL Listed, CSA certified		NA Certification	UL Listed, CSA certified
	Specially designed for NA	✓		Specially designed for NA	✓
	Suitable for	PKZM0/PKE, line terminal required for Type E/F applications		Suitable for	PKZM4/PKE, line terminal required for Type E/F applications

Circuit-breakers	Length	Unit width	Part no.	Price	Std. pack	Information relevant for export to North America
Number	mm	mm	Article no.	See price list		
Three-phase commoning links						
Finger- and back-of-hand-proof, short-circuit proof $U_e=690\text{ V}$, $I_u=128\text{ A}$						
For PKZM4 without side-mounted auxiliary contacts or voltage releases						
	2	110	55	B3.0/2-PKZ4 220220	1 off 	Product Standards UL 508; CSA-C22.2 No. 14; IEC60947-4-1; CE marking UL File No. E36332 UL CCN NLRV CSA File No. 12528 CSA Class No. 3211-06 NA Certification UL Listed, CSA certified
	3	165		B3.0/3-PKZ4 220221		
	4	220		B3.0/4-PKZ4 220222		
For PKZM4 with one auxiliary contact or trip-indicating auxiliary contact each fitted on the right side						
	2	119	55 + 9	B3.1/2-PKZ4 220223	1 off 	
	3	183		B3.1/3-PKZ4 220224		
	4	247		B3.1/4-PKZ4 220225		
For PKZM4 with one auxiliary contact or trip-indicating auxiliary contact each fitted to right side, or one voltage release fitted to left side						
	2	128	55 + 18	B3.2/2-PKZ4 220226	1 off 	
	4	274		B3.2/4-PKZ4 220227		
Shroud for unused terminals						
Protection against direct contact. To cover unused terminals on three-phase commoning link						
	-	-	-	H-B3-PKZ4 220228	10 off 	Product Standards UL 508; CSA-C22.2 No. 14; IEC60947-4-1; CE marking UL File No. E36332 UL CCN NLRV CSA File No. 12528 CSA Class No. 3211-06 NA Certification UL Listed, CSA certified

HPL07029EN

Actuating voltage	Part no. Article no.	Price See price list	Std. pack	Part no. Article no.	Price See price list	Std. pack	Notes
Shunt release, undervoltage release							
AC							
Standard voltage							
24 V 50 Hz	A-PKZ0(24V50HZ)¹⁾ 073181		2 off  	U-PKZ0(24V50HZ)¹⁾ 073129		2 off  	
110 V 50 Hz	A-PKZ0(110V50HZ)¹⁾ 073184		2 off  	U-PKZ0(110V50HZ)¹⁾ 073132		2 off  	
220 V 50 Hz	A-PKZ0(220V50HZ)¹⁾ 073186		2 off  	U-PKZ0(220V50HZ)¹⁾ 073134		2 off  	
230 V 50 Hz	A-PKZ0(230V50HZ)¹⁾ 073187		2 off  	U-PKZ0(230V50HZ)¹⁾ 073135		2 off  	Only A(U)-PKZ0... with serial number 02 or higher can be fitted
240 V 50 Hz	A-PKZ0(240V50HZ)¹⁾ 073188		2 off  	U-PKZ0(240V50HZ)¹⁾ 073136		2 off  	
380 V 50 Hz	A-PKZ0(380V50HZ)¹⁾ 073189		2 off  	U-PKZ0(380V50HZ)¹⁾ 073137		2 off  	
400 V 50 Hz	A-PKZ0(400V50HZ)¹⁾ 073190		2 off  	U-PKZ0(400V50HZ)¹⁾ 073138		2 off  	
415 V 50 Hz	A-PKZ0(415V50HZ)¹⁾ 073191		2 off  	U-PKZ0(415V50HZ)¹⁾ 073139		2 off  	
120 V 60 Hz	A-PKZ0(120V60HZ)¹⁾ 073195		2 off  	U-PKZ0(120V60HZ)¹⁾ 073143		2 off  	
240 V 60 Hz	A-PKZ0(240V60HZ)¹⁾ 073198		2 off  	U-PKZ0(240V60HZ)¹⁾ 073146		2 off  	
440 V 60 Hz	A-PKZ0(440V60HZ)¹⁾ 082164		2 off  	U-PKZ0(440V60HZ)¹⁾ 082161		2 off  	
480 V 60 Hz	A-PKZ0(480V60HZ)¹⁾ 073199		2 off  	U-PKZ0(480V60HZ)¹⁾ 073147		2 off  	
Non-standard voltages not covered by above standard voltages							
... V 50 Hz (24 - 500 V)	A-PKZ0(*V50HZ)¹⁾ 982165		2 off  	U-PKZ0(*V50HZ) 982162			The part number for ordering consists of the basic part number and the actuating voltage. For non-standard voltages, specify the required actuating voltage within the indicated range (... - ... V). Minimum order quantity is 10 units
... V 60 Hz (24 - 600 V)	A-PKZ0(*V60HZ)¹⁾ 982166		2 off  	U-PKZ0(*V60HZ) 982163			
DC							
Standard voltage							
24 V DC	A-PKZ0(24VDC)¹⁾ 073200		2 off  				PKE can be fitted only with A(U)-PKZ0... with serial number 02 or higher.
110 V DC	A-PKZ0(110VDC)¹⁾ 073203		2 off  				



Information relevant for export to North America



1)

Product Standards	UL 508; CSA-C22.2 No. 14; IEC60947-4-1; CE marking
UL File No.	E36332
UL CCN	NLRV
CSA File No.	12528
CSA Class No.	3211-05
NA Certification	UL Listed, CSA certified

PKZ, PKZM

Engineering

1- and 2-pole-connected PKZM0, PKZM4 and PKZ2 with AC and DC



2-pole-connected PKZM0(1) and PKZM4 with CL-PKZO

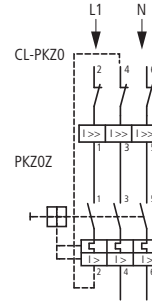

Protection of PVC-insulated cables against thermal overload on short-circuits

The table specifies which minimum conductor cross-sections are protected by motor-protective circuit-breaker PKZ(M) up to their rated conditional short-circuit current I_q .

Min. cross-section protected 380 – 415 V, 50 Hz, Cu mm ²					Device Part no.
4	2.5	1.5	1	0.75	
					PKZM0-0,16
					PKZM0-6,3
					PKZM0-10
					PKZM0-12
					PKZM0-16
					PKZM0-20
					PKZM0-25
					PKZM0-32
					PKZM4-16
					PKZM4-25
					PKZM4-32
					PKZM4-40
					PKZM4-50
					PKZM4-58
					PKZM4-63

Min. cross-section protected 380 – 415 V, 50 Hz, Cu mm ²		Device Part no.
		PKZ2/ZM-0,6
		PKZ2/ZM-2,4
		PKZ2/ZM-4
		PKZ2/ZM-6
		PKZ2/ZM-10
		PKZ2/ZM-16
		PKZ2/ZM-25
		PKZ2/ZM-32
PKZ2/ZM-40		

PKZM0-...T tripping characteristics (not for PKM0-...), PKZM01

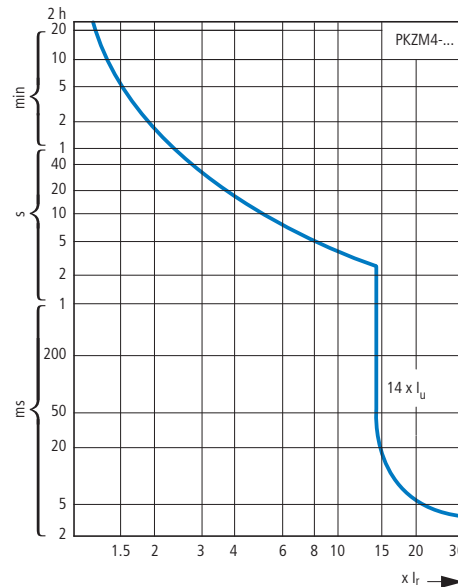
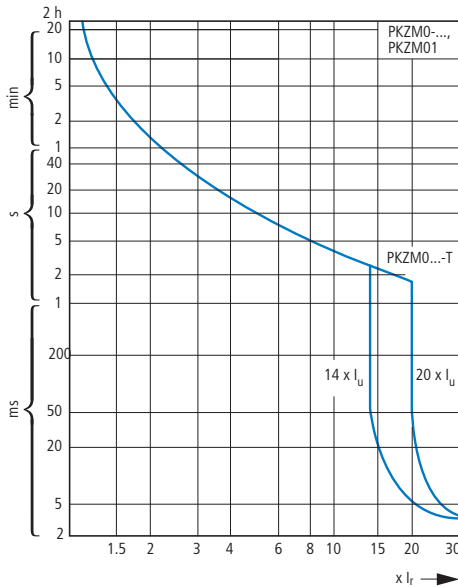

PKZM, PKE

Tripping characteristic curves, wide-range circuit-breaker PKE

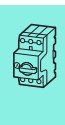
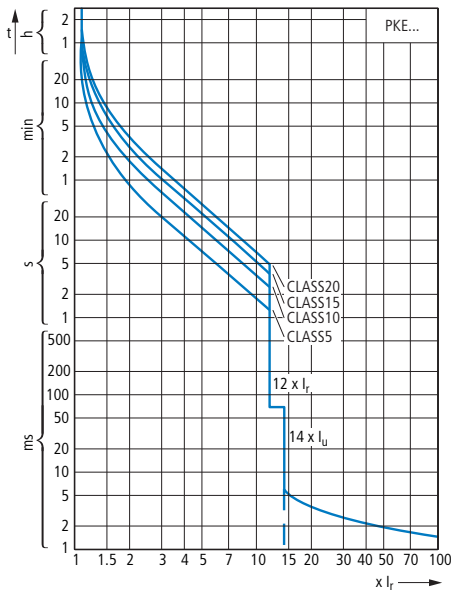

Let-through characteristics, motor-protective circuit-breaker, transformer-protective circuit-breakers, circuit-breaker for starter combinations

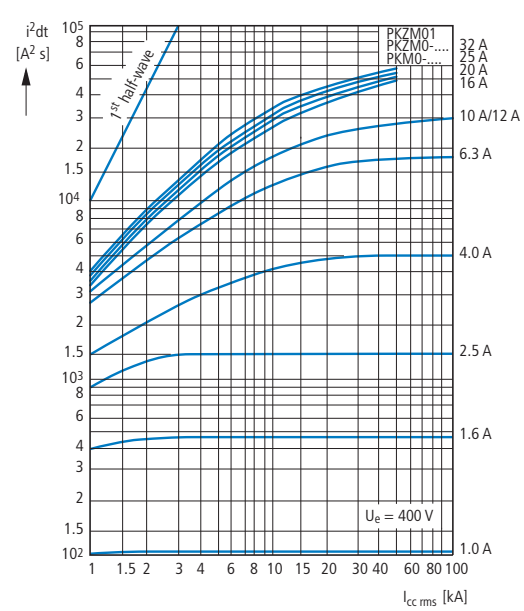
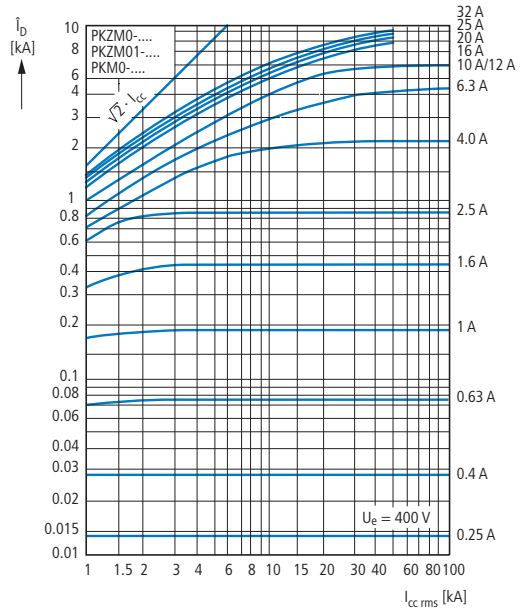

Motor-protective circuit-breaker let-through characteristics

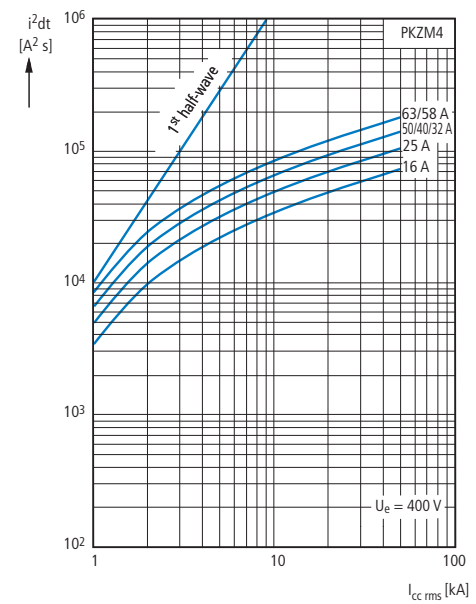
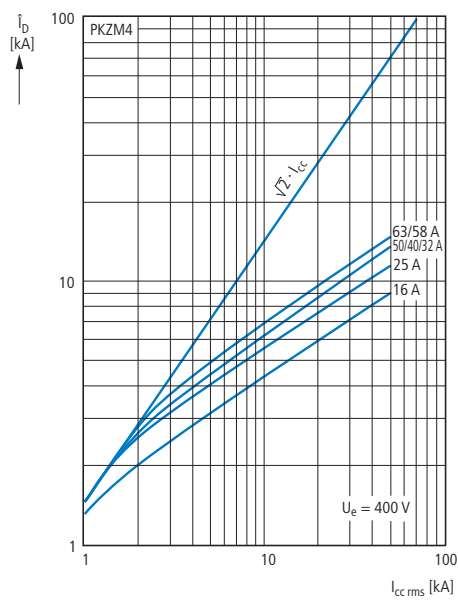

Circuit-breaker switching capacity from serial no. 04

Rated uninterrupted current I_u

Rated conditional short-circuit current I_q IEC/EN 60947-4-1

Rated ultimate short-circuit breaking capacity I_{cu} } IEC/EN 60947-2
 Rated breaking capacity I_{cs}

I_u A	230 V				400 V				440 V				500 V				690 V			
	I_q kA	I_{cu} kA	I_{cs} kA	A ¹⁾	I_q kA	I_{cu} kA	I_{cs} kA	A ¹⁾	I_q kA	I_{cu} kA	I_{cs} kA	A ¹⁾	I_q kA	I_{cu} kA	I_{cs} kA	A ¹⁾	I_q kA	I_{cu} kA	I_{cs} kA	A ¹⁾

PKZM0, PKZM0...-T, PKM0 with type "1" and "2" coordination

0.16 – 1	150	150	150	N	150	150	150	N				N				N				N
1.6	150	150	150	N	150	150	150	N				N				N				N
2.5	150	150	150	N	150	150	150	N				N				N	5	5	5	50
4	150	150	150	N	150	150	150	N				N				N	3	3	3	50
6.3	150	150	150	N	150	150	150	N				N	42	42	11	50	3	3	2	50
10	150	150	150	N	150	150	150	N	42	42	12	50	42	42	11	50	3	3	2	50
12	50	50	13	50	50	50	13	50	15	15	12	50	15	15	8	50	3	3	2	50
16	50	50	13	50	50	50	13	50	15	15	12	50	15	15	8	50	3	3	2	50
20	50	50	13	50	50	50	13	50	10	10	13	50	6	6	3	50	3	3	1	50
25	50	50	13	50	50	50	13	50	10	10	13	50	6	6	3	50	3	3	1	50
32	50	50	13	50	50	50	13	50	10	10	13	50	6	6	3	50	3	3	1	50

PKZM0 (PKZM0...-T, PKM0) + CL-PKZ0

0.16 – 1				N				N				N				N			20	N
1.6				N				N				N				N			20	N
2.5				N				N				N				N	20	20	20	N
4				N				N				N				N	20	20	20	N
6.3				N				N				N			50	N	20	20	20	N
10				N				N				N			20	N	20	20	20	N
12				N				N				N			20	N	5	5	2.5	N
16				N				N				N			20	N	5	5	2.5	N
20				N				N				N	10	10	10	N	5	5	2.5	N
25				N				N				N	10	10	10	N	5	5	2.5	N
32				N				N				N	10	10	10	N	5	5	2.5	N

PKZM0 (PKZM0...-T, PKM0) + 2 CL-PKZ0

0.16 – 1				N				N				N				N			20	N
1.6				N				N				N				N			20	N
2.5				N				N				N				N	40	40	20	N
4				N				N				N				N	40	40	20	N
6.3				N				N				N			50	N	20	20	20	N
10				N				N				N			40	N	20	20	20	N
12				N				N				N			40	N	10	10	2.5	N
16				N				N				N			40	N	10	10	2.5	N
20				N				N				N	20	20	20	N	10	10	2.5	N
25				N				N				N	20	20	20	N	10	10	2.5	N
32				N				N				N	20	20	20	N	10	10	2.5	N

Notes

■ No upstream protective device required, as it is the auto-protected range (100/150 kA)

¹⁾ Required back-up fuse if the short-circuit current exceeds the device's rated conditional short-circuit current ($I_{cc} > I_q$).

N Not necessary

Circuit-breaker switching capacity

Rated uninterrupted current I_u

Rated conditional short-circuit current I_q IEC/EN 60947-4-1

Rated maximum short-circuit breaking capacity I_{cu}
Rated breaking capacity I_{cs} } IEC/EN 60947-2

I_u A	230 V				400 V				440 V ²⁾				500 V ²⁾				690 V ²⁾			
	I_q kA	I_{cu} kA	I_{cs} kA	A ¹⁾	I_q kA	I_{cu} kA	I_{cs} kA	A ¹⁾	I_q kA	I_{cu} kA	I_{cs} kA	A ¹⁾	I_q kA	I_{cu} kA	I_{cs} kA	A ¹⁾	I_q kA	I_{cu} kA	I_{cs} kA	A ¹⁾
PKZM01 with type "1" and "2" coordination																				
0.16 – 1	50	50	50	50	50	50	50	50	50	50	50	50	50	50	50	50	50	50	50	50
1.6	50	50	50	50	50	50	50	50	50	50	50	50	50	50	50	50	50	50	50	50
2.5	50	50	50	50	50	50	50	50	50	50	50	50	50	50	50	50	50	50	50	50
4	50	50	50	50	50	50	50	50	50	50	50	50	50	50	50	50	50	50	50	50
6.3	50	50	50	50	50	50	50	50	50	50	50	50	50	50	50	50	50	50	50	50
10	50	50	50	50	50	50	50	50	42	42	10	50	42	42	10	50	42	42	10	50
12	50	50	10	50	50	50	10	50	15	15	10	50	15	15	10	50	15	15	10	50
16	50	50	10	50	50	50	10	50	15	15	10	50	15	15	10	50	15	15	10	50
20, 25	50	50	10	50	50	50	10	50	10	10	3	50	10	10	3	50	10	10	3	50
PKZM4 with type "1" and "2" coordination																				
16	150	150	25	N	150	150	25	N	45	45	25	100	15	15	100	8	8	2.5	100	
25	150	150	25	N	150	150	25	N	45	45	25	100	15	15	100	8	8	2.5	100	
32	50	50	25	100	50	50	25	100	45	45	25	100	15	15	100	5	5	2.5	100	
40	50	50	25	100	50	50	25	100	45	45	25	100	15	15	100	5	5	2.5	100	
50	50	50	25	100	50	50	25	100	45	45	25	100	15	15	100	5	5	2.5	100	
58	50	50	25	160	50	50	25	160	45	45	25	160	15	15	160	5	5	2.5	160	
63	50	50	25	160	50	50	25	160	45	45	25	160	15	15	160	5	5	2.5	160	
PKE12... ²⁾ with type of coordination „1" and																				
0.3 - 1.2	100		50		100		50		50		50		10		50		3		50	
1 - 4	100		50		100		50		50		50		10		50		3		50	
3 - 12	100		50		100		50		15		50		10		50		3		50	
PKE32... ²⁾ with type of coordination „1" and																				
3 - 12	100		50		100		50		15		50		6		50		3		50	
8 - 32	100		50		100		50		25		50		6		50		3		50	

Notes

- No upstream protective device required, as it is the auto-protected range (150 kA)
- N Not necessary

- ¹⁾ Fuse (A gG/gL) for increasing the switching capacity of the motor-protective circuit-breaker to 100 kA
- ²⁾ Please enquire for additional information regarding voltages >400 V and device combinations with CL-PKZ0.

Motor-protective circuit-breaker internal resistances

	Impedance	Heat dissipation (3 pole at operating temperature)	Rated uninterrupted current I_u
	Ω	W	A
PKZM0-0.16	78	6	0.16
PKZM0-0.25	32	6	0.25
PKZM0-0.4	13	6	0.4
PKZM0-0.63	5	6	0.63
PKZM0-1	2	6	1
PKZM0-1.6	0.8	6	1.6
PKZM0-2.5	0.32	6	2.5
PKZM0-4	0.13	6	4
PKZM0-6.3	0.050	6	6.3
PKZM0-10	0.020	6	10
PKZM0-12	0.014	6	12
PKZM0-16	0.008	6	16
PKZM0-20	0.005	6	20
PKZM0-25	0.003	6	25
PKZM0-32	0.002	6	32

	Impedance	Heat dissipation (3 pole at operating temperature)	Rated uninterrupted current I_u
	Ω	W	A
PKZM4-16	0.029	22	16
PKZM4-25	0.012	22	25
PKZM4-32	0.007	22	32
PKZM4-40	0.005	22	40
PKZM4-50	0.003	22	50
PKZM4-58	0.002	22	58
PKZM4-63	0.002	22	65
PKZ2-ZM-0.6	13	14	0.6
PKZ2-ZM-1	5	14	1
PKZ2-ZM-1.6	2	14	1.6
PKZ2-ZM-2.4	0.8	14	2.4
PKZ2-ZM-4	0.29	14	4
PKZ2-ZM-6	0.13	14	6
PKZ2-ZM-10	0.05	14	10
PKZ2-ZM-16	0.018	14	16
PKZ2-ZM-25	0.007	14	25
PKZ2-ZM-32	0.005	14	32
PKZ2-ZM-40	0.003	14	40



Approvals for world markets

Rating data for approved types ¹⁾ UL 508/CSA C 22.2 No. 14	Maximum motor rating				Setting ranges		Maximum protective device to UL/CSA					
	Three-phase current				Overload releases	Short-circuit-releases	Group protection ²⁾					
	200 V	230 V	460 V	575 V			Up to max. short-circuit current	Maximum fuse rating	Maximum circuit breaker			
	HP	HP	HP	HP	A	A	600 V	with CL	with CL	with CL		
							kA	kA	A	A	A	A
Motor-protective circuit-breakers PKZM01	"Manual Motor Starter with thermal and magnetic trip"											
PKZM01-0,16	3)				0.1 – 0.16	2.2	50	600	600			
PKZM01-0.25					0.16 – 0.25	3.4	50	600	600			
PKZM01-0.4					0.25 – 0.4	5.6	50	600	600			
PKZM01-0.63					0.4 – 0.63	8.8	50	600	600			
PKZM01-1					0.63 – 1	14	50	600	600			
PKZM01-1,6			¾	¾	1 – 1.6	22	50	600	600			
PKZM01-2.5	½	½	1	1½	1.6 – 2,5	35	50	600	600			
PKZM01-4	¾	¾	2	3	2.5 – 4	56	50	600	600			
PKZM01-6,3	1	1½	3	5	4 – 6.3	88	50	600	600			
PKZM01-10	3	3	7½	10	6.3 – 11	140	22	50	150	600	125	600
PKZM01-12	3	3	7½	10	9 – 12	168	18	50	150	600	125	600
PKZM01-16	3	5	10	10	10 – 16	224	10	50	150	600	125	600
PKZM01-20	5	-	-	15	16 – 20	280	10	18	150	600	125	600
PKZM01-25	-	7½	15	20	20 – 25	350	10	18	150	600	125	600
Motor-protective circuit-breakers PKZM01	"Manual Motor Starter with thermal and magnetic trip"											
PKZM0-0,16	3)				0.1 – 0.16	2.2	50	600	600			
PKZM0-0.25					0.16 – 0.25	3.4	50	600	600			
PKZM0-0.4					0.25 – 0.4	5.6	50	600	600			
PKZM0-0.63					0.4 – 0.63	8.8	50	600	600			
PKZM0-1					0.63 – 1	14	50	600	600			
PKZM0-1.6			¾	¾	1 – 1.6	22	50	600	600			
PKZM0-2.5	½	½	1	1½	1.6 – 2,5	35	50	600	600			
PKZM0-4	¾	¾	2	3	2.5 – 4	56	50	600	600			
PKZM0-6.3	1	1½	3	5	4 – 6.3	88	50	600	600			
PKZM0-10	3	3	7½	10	6.3 – 11	140	22	50	150	600	125	600
PKZM0-12	3	3	7½	10	9 – 12	168	18	50	150	600	125	600
PKZM0-16	3	5	10	10	10 – 16	224	10	50	150	600	125	600
PKZM0-20	5	-	-	15	16 – 20	280	10	18	150	600	125	600
PKZM0-25	-	7½	15	20	20 – 25	350	10	18	150	600	125	600
PKZM0-32	7½	10	20	25	24 – 32	448	10	18	150	600	125	600
Motor-protective circuit-breakers PKZM4												
PKZM4-16	3	5	10	15	10 – 16	224	50	600	600			
PKZM4-25	7½	7½	20	25	16 – 25	350	50	600	600			
PKZM4-32	10	10	25	30	25 – 34	448	50	600	600			
PKZM4-40	10	15	30	40	32 – 42	560	50	600	600			
PKZM4-50	10	15	30	40	40 – 52	700	10	600	600			
PKZM4-58	15	15	40	50	50 – 56	812	10	600	600			
PKZM4-63	15	15	40	50	52 – 58	882	10	600	600			

Notes

Service factor (SF)

Set value I_r , on the current scale, depending on the load factor

$$SF = 1.15 \rightarrow I_r = 1 \times I_{n \text{ mot}}$$

$$SF = 1 \rightarrow I_r = 0.9 \times I_{n \text{ mot}}$$

¹⁾ Devices for world markets IEC \triangleq UL/CSA²⁾ Caution: Changed requirements for group protection³⁾ Calculate motor output in this range according to rated operational current. Specified values as per NEC Table 430 – 150

Rating data for approved types ¹⁾ UL 508/CSA C 22.2 No. 14		For use with	Pilot Duty	General Use	
Accessories					
Standard auxiliary contacts	NHI11-PKZ0	PKZM0(-T) PKZM4	A 600, Q 300	5 A – 600 V AC 1 A – 250 V DC	–
	NHI12-PKZ0				
	NHI21-PKZ0				
	NHI2-11S-PKZ0				
	NHI-E-11-PKZ0				
	NHI-E-10-PKZ0		E150	0.5 A – 250 V AC	–
Early-make auxiliary contacts	VHI20-PKZ0	PKZM0(-T)	E150	0.5 A – 250 V AC	–
	VHI20-PKZ01	PKZM01			
Trip indicators	AGM2-10-PKZ0	PKZM0(-T) PKZM4	A 600, Q 300	5 A – 600 V AC 1 A – 250 V DC	–
	AGM2-01-PKZ0				
Shunt release	A-PKZ0(...)	PKZM0(-T) PKZM4	–	–	Actuating voltages and ordering information → Products for the German market
	U-PKZ0(...)				
Auxiliary contact for contact module	HI11-S/EZ-PKZ0	PKZM0	A 600, Q 300	5 A – 600 V AC 1 A – 250 V DC	–



Notes

¹⁾ Devices for world markets IEC = UL/CSA

Motor-protective circuit-breakers PKZM0(4) used as "Manual self-protected Motor Starters" – UL 508 Type E

Maximum motor output AC				Setting ranges		Interrupting Capacity = Short Circuit Current (SCCR)			Components	Accessories
200 V	230 V	460 V	575 V	Overload releases	Short-circuit releases	240 V	480V/ 277 V ²⁾	600V/ 347 V ²⁾	Motor Protector	
208 V	240 V	480 V	600 V			[kA]	[kA]	[kA]	Part no.	Part no.
[HP]	[HP]	[HP]	[HP]	[A]	[A]					
¹⁾				0.1 – 0.16	2.2	65	65	50	PKZM0-0.16	BK25/3-PKZ0-E
				0.16 – 0.25	3.4	65	65	50	PKZM0-0.25	BK25/3-PKZ0-E
				0.25 – 0.4	5.6	65	65	50	PKZM0-0.4	BK25/3-PKZ0-E
				0.4 – 0.63	8.8	65	65	50	PKZM0-0.63	BK25/3-PKZ0-E
				0.63 – 1	14	65	65	50	PKZM0-1	BK25/3-PKZ0-E
		³ / ₄	³ / ₄	1 – 1.6	22	65	65	50	PKZM0-1.6	BK25/3-PKZ0-E
¹ / ₂	¹ / ₂	1	1½	1.6 – 2,5	35	65	65	50	PKZM0-2.5	BK25/3-PKZ0-E
³ / ₄	³ / ₄	2	3	2.5 – 4	56	65	65	50	PKZM0-4	BK25/3-PKZ0-E
1	1½	3	5	4 – 6.3	88	65	65	50	PKZM0-6.3	BK25/3-PKZ0-E
3	3	7½	10	6.3 – 11	140	65	65	50	PKZM0-10	BK25/3-PKZ0-E
3	3	7½	–	9 – 12	168	65	65	–	PKZM0-12	BK25/3-PKZ0-E
3	5	10	–	10 – 16	224	42	42	–	PKZM0-16	BK25/3-PKZ0-E
5	–	–	–	16 – 20	280	18	18	–	PKZM0-20	BK25/3-PKZ0-E
–	7½	15	–	20 – 25	350	18	18	–	PKZM0-25	BK25/3-PKZ0-E
7½	10	20	–	24 – 32	448	18	18	–	PKZM0-32	BK25/3-PKZ0-E
3	5	10	10	10 – 16	224	65	65	25	PKZM4-16	BK50/3-PKZ4-E
5	7½	15	20	16 – 27	350	65	65	25	PKZM4-25	BK50/3-PKZ4-E
7½	10	20	30	24 – 34	448	65	65	25	PKZM4-32	BK50/3-PKZ4-E
10	–	30	30	32 – 40	560	65	65	25	PKZM4-40	BK50/3-PKZ4-E
–	15	30	–	40 – 52	700	65	65	–	PKZM4-50	BK50/3-PKZ4-E
–	–	40	–	50 – 56	812	65	65	–	PKZM4-58	BK50/3-PKZ4-E
–	–	40	–	52 – 58	882	65	–	–	PKZM4-63	BK50/3-PKZ4-E

Notes

¹⁾ Calculate motor power in this range according to the rated current. Stated values to NEC Table 430 -150
²⁾ Suitable for networks with grounded star-point

Technical data

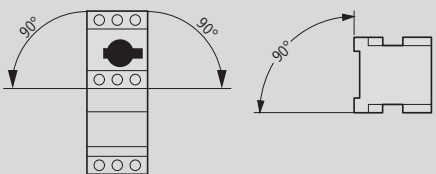
			PKZM01...	PKZM0-... ¹⁾
General				
Standards			IEC/EN 60947, VDE 0660, UL 508, CSA C 22.2 No. 14	
Climatic proofing			Damp heat, constant, to IEC 60068-2-78 Damp heat, cyclic, to IEC 60068-2-30	
Ambient temperature	Storage	°C	-25...80	-25...80
	Open	°C	-25...55	-25...55
	Encapsulated	°C	-25...40	-25...40
Built-in position				
Direction of incoming supply			Any	Any
Degree of protection	Device		IP20	IP20
	Terminals		IP00	IP00
Contact protection to EN 50274			Finger- and back-of-hand proof	
Shock resistance, half-sinusoidal shock, 10 ms to IEC 60068-2-27		g	25	25
Installation altitude		m	max. 2000	max. 2000
Terminal capacity, screw terminals	Solid	mm ²	1 x (1 - 6) 2 x (1 - 6)	1 x (1 - 6) 2 x (1 - 6)
	Flexible with ferrule to DIN 46228	mm ²	1 x (1 - 6) 2 x (1 - 6)	1 x (1 - 6) 2 x (1 - 6)
	Solid or stranded	AWG	18 - 10	18 - 10
Terminal capacity, spring-loaded terminals	Solid	mm ²	–	1 x (1...2.5) 2 x (1...2.5)
	Flexible with ferrule to DIN 46228	mm ²	–	1 x (1...2.5) 2 x (1...2.5)
	Solid or stranded	AWG	–	18...14
Terminal screw tightening torque	Main conductors	Nm	1.7	1.7
	Auxiliary conductors	Nm	1	1
Main contacts				
Rated impulse withstand voltage	U_{imp}	V AC	6000	6000
Overvoltage category/pollution degree			III/3	III/3
Rated operational voltage	U_e	V AC	690	690
Rated uninterrupted current = rated operational current	$I_u = I_e$	A	16 or current setting of the overcurrent release	32 or current setting of the overcurrent release
Rated frequency		Hz	40 - 60	40 - 60
Heat dissipation (3 pole at operating temperature)		W	6	6
Lifespan, mechanical	Operations	x 10 ⁶	0.05	0.1
Lifespan, electrical (AC-3 at 400 V)	Operations	x 10 ⁶	0.05	0.1
Maximum operating frequency	Operations/h	Ops/h	25	40
Short-circuit rating				
AC			→ Page 7/33	→ Page 7/32
DC		kA	60	60 (up to PKZM0-16) 40 (PKZM0-20 to PKZM0-32)
Motor switching capacity				
AC-3 up to 690 V		A	16	32
DC-5 (up to 250 V)		A	16 (3 contacts in series)	25 (3 contacts in series)
Trip blocks				
Temperature compensation				
To IEC/EN 60947, VDE 0660		°C	-5...40	-5...40
Operating range		°C	-25...55	-25...55
Temperature compensation residual error for T > 40 °C		%/K	≤ 0.25	≤ 0.25
Setting range of overload releases		x I_u	0.6 - 1	0.6 - 1
Short-circuit releases tolerance		%	± 20	± 20
Phase-failure sensitivity			IEC/EN 60947-4-1, VDE 0660 Part 102	IEC/EN 60947-4-1, VDE 0660 Part 102

Notes

¹⁾ Tested according to IEC/EN 60947-1 (isolating characteristics) and IEC/EN 60947-2

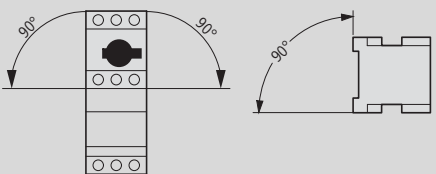
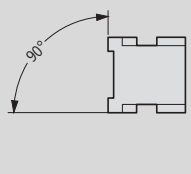
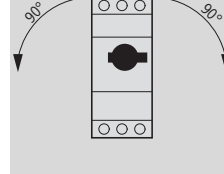
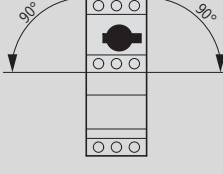
PKM0-...	PKZM0-...-T	PKZM4	PKE
IEC/EN 60947, VDE 0660, UL 508, CSA C 22.2 No. 14			
Damp heat, constant, to IEC 60068-2-78 Damp heat, cyclic, to IEC 60068-2-30			
-25...80	-25...80	-25...70	-25...80
-25...55	-25...55	-25...55	-25...55
-25...40	-25...40	-25...40	-25...40
			
Any	Any	Any	Any
IP20	IP20	IP20	IP20
IP00	IP00	IP00	IP00
Finger- and back-of-hand proof			
25	25	15	25
max. 2000	max. 2000	max. 2000	max. 2000
1 x (1 - 6) 2 x (1 - 6)	1 x (1 - 6) 2 x (1 - 6)	1 x (1 - 50) 2 x (1 - 35)	1 x (1 - 6) 2 x (1 - 6)
1 x (1 - 6) 2 x (1 - 6)	1 x (1 - 6) 2 x (1 - 6)	1 x (1 - 35) 2 x (1 - 35)	1 x (1 - 6) 2 x (1 - 6)
18 - 10	18 - 10	14 - 2	18 - 10
1 x (1...2.5) 2 x (1...2.5)	–	–	1 x (1...2.5) 2 x (1...2.5)
1 x (1...2.5) 2 x (1...2.5)	–	–	1 x (1...2.5) 2 x (1...2.5)
18...14	–	–	18...14
1.7	1.7	3.3	1.7
1	1	1	1
6000	6000	6000	6000
III/3	III/3	III/3	III/3
690	690	690	690
32 or current setting of the overcurrent release	25 or current setting of the overcurrent release	65 Open 63 enclosed	32 A or set current of the overcurrent release
40 - 60	40 - 60	40 - 60	40 - 60
6	6	22	6
0.1	0.1	0.03	0.05
0.1	0.1	0.03	0.05
40	40	40	60
→ Page 7/32	→ Page 7/32	→ Page 7/33	→ Page 7/33
60 (up to PKM0-16) 40 (PKM0-20 to PKM0-32)	60 (up to PKZM0-16) 40 (PKZM0-20 to PKZM0-32)	60	–
32	25	65	32
25 (3 contacts in series)	25 (3 contacts in series)	63 (3 contacts in series)	–
-5...40	-5...40	-5...40	-5...40
-25...55	-25...55	-25...55	-25...55
≤ 0.25	≤ 0.25	≤ 0.25	–
0.6 - 1	0.6 - 1	0.6 - 1	0.25 - 1
± 20	± 20	± 20	± 20
–	IEC/EN 60947-1-1, VDE 0660 Part 102	IEC/EN 60947-4-1, VDE 0660 Part 102	Yes

				NHI...PKZ0	NHI-E-...PKZ0	VHI...PKZ0	AGM
Auxiliary contacts							
Rated impulse withstand voltage	U_{imp}	V AC		6000	4000	4000	6000
Overvoltage category/pollution degree				III/3	III/3	III/3	III/3
Rated operating voltage							
	U_e	V AC		500	440	440	500
	U_e	V DC		250	250	250	250
Safe isolation according to EN 61140							
Between auxiliary contacts and main contacts			V AC	690	690	690	690
Rated operational current							
AC-15							
	220 - 240 V	I_e	A	3.5	1	1	3.5
	380 - 415 V	I_e	A	2	–	–	2
	440 - 500 V	I_e	A	1	–	–	1
DC-13 L/R \leq 100 ms							
	24 V	I_e	A	2	2	2	2
	60 V	I_e	A	1.5	–	–	1.5
	110 V	I_e	A	1	–	–	1
	220 V	I_e	A	0.25	–	–	0.25
Durability							
Lifespan, mechanical		Operations	$\times 10^6$	> 0.1	> 0.1	> 0.1	> 0.01
Lifespan, electrical		Operations	$\times 10^6$	> 0.05	> 0.1	> 0.1	> 0.05
Control circuit reliability (at $U_e = 24$ V DC, $U_{min} = 17$ V, $I_{min} = 5.4$ mA)			Fault probability	$< 10^{-8} < 1$ failure in 1×10^8 operations			
Interlocked opposing contacts				Yes	–	–	–
Short-circuit rating without welding							
Fuseless				FAZ-B4/1-HI	–	–	FAZ-B4/1-HI
Fuse			A gG/gL	10	10	10	10
Terminal capacity							
Solid or flexible conductor with ferrule			mm ²	0.75 - 2.5	0.75 - 1.5	0.75 - 1.5	0.75 - 2.5
Solid or stranded			AWG	18 - 14	18 - 16	18 - 16	18 - 14

				Undervoltage release U-PKZ...	Shunt release A-PKZ...
General					
Terminal capacity					
Solid or flexible conductor with ferrule			mm ²	1 x (0.75 - 2.5) 2 x (0.75 - 2.5)	1 x (0.75 - 2.5) 2 x (0.75 - 2.5)
Solid or stranded			AWG	1 x (18 - 14) 2 x (18 - 14)	1 x (18 - 14) 2 x (18 - 14)
Main contacts					
Rated operating voltage		U_e	V AC	42 - 480	42 - 480
Rated operating voltage		U_e	V DC	24 - 250	24 - 250
Pick-up-/drop-out voltage					
Pick-up voltage		$x U_s$		0.85 - 1.1	
Drop-out voltage		$x U_s$		0.7 - 0.35	
Operating range					
AC voltage			$x U_s$		0.7...1.1
DC voltage (intermittent operation 5 s)			$x U_s$		0.7...1.1
Power consumption					
AC voltage					
AC pick-up rating		Pick-up	VA	5	5
AC consumption when closed		Holding	VA	3	3
DC voltage					
DC pick-up rating		Pick-up	W	–	3
DC consumption when closed		Holding	W	–	3

Dimensions

Motor-protective circuit-breaker
PKZM01...

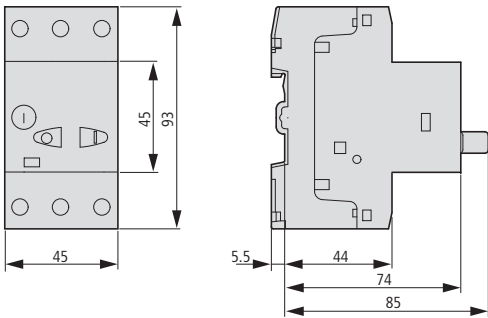

Motor-protective circuit-breaker
Transformer-protective circuit-breakers
Motor-protective circuit-breaker with
standard auxiliary contacts
PKZM0...(+NHI-E-...-PKZ0)
PKZM0...-T(+NHI-E-...-PKZ0)
PKM0...(+NHI-E-...-PKZ0)

Motor-protective circuit-breakers with lockable rotary handles

PKZM0-...+AK-PKZ0

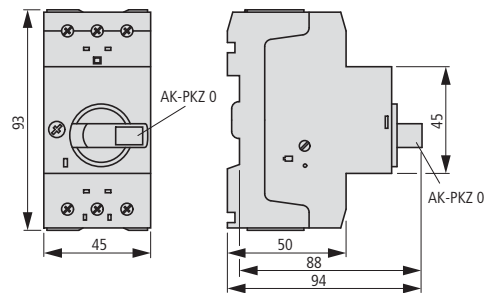
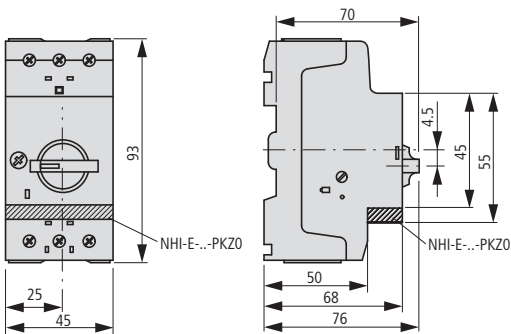

Current limiters
CL-PKZ...

Motor-protective circuit-breakers with early-make auxiliary contacts
PKZM0-...+VHI-...-PKZ0

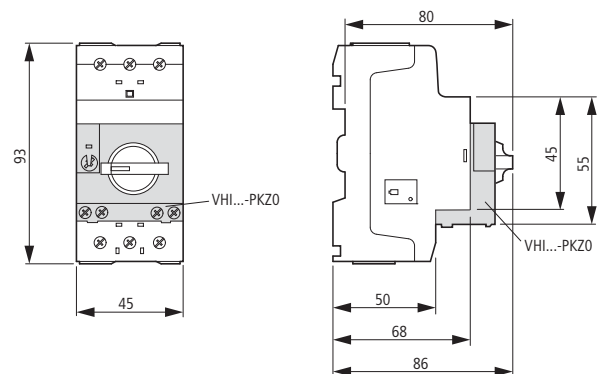
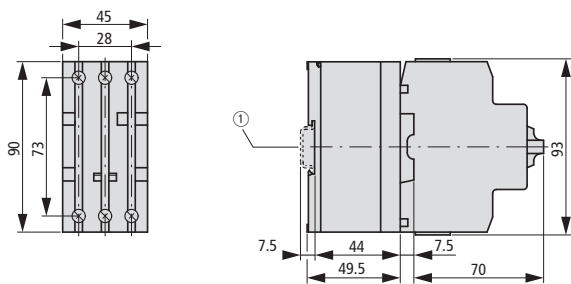

① Top-hat rail IEC/EN 60715

Standard auxiliary contacts

NHI...-PKZ0

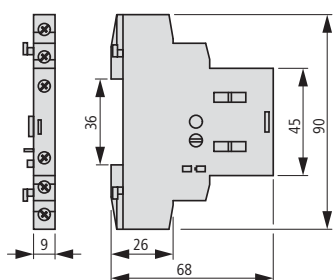

Trip indicators

AGM2...-PKZ0

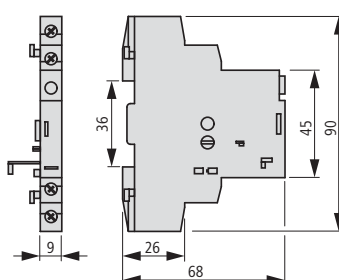

Shunt release

Undervoltage release

A-PKZ0...

U-PKZ0...

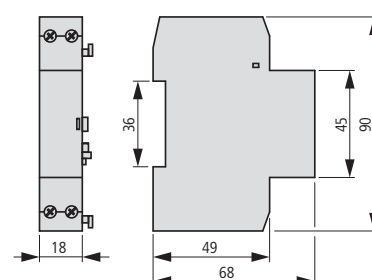

BBA0-25

BBA0-25/2TS

BBA0/2TS-L

BBA0-32

BBA0-32/2TS-C

BBA0C-16

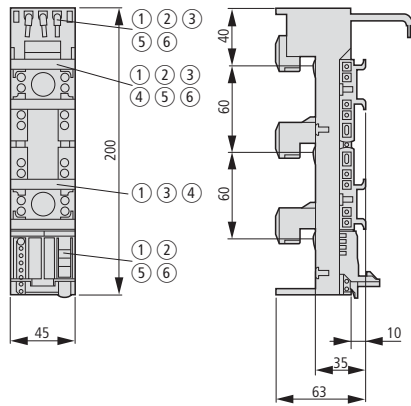

- ① BBA0-32/2TS-C
- ② BBA0-25/2TS
- ③ BBA0C-16
- ④ BBA0/2TS-L
- ⑤ BBA0-25
- ⑥ BBA0-32

BBA2-63

BBA2-63/2TS

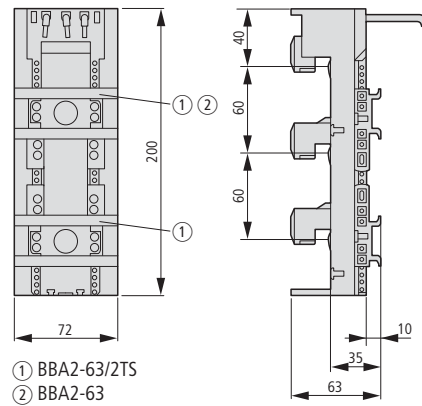

- ① BBA2-63/2TS
- ② BBA2-63

BBA4/2TS-L

BBA4L-63

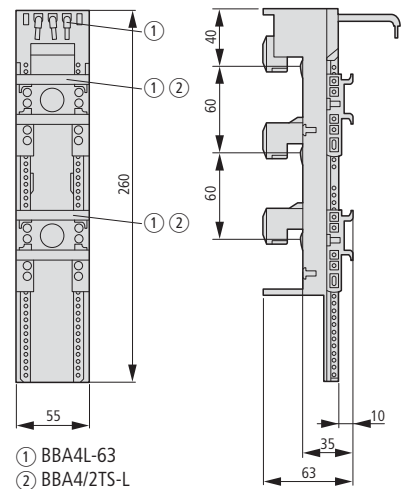

- ① BBA4L-63
- ② BBA4/2TS-L

BBA4-63

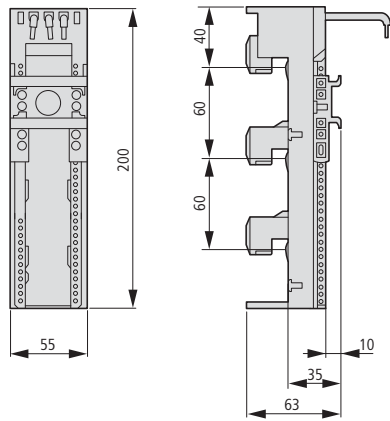

BBA2-80/2TS-S

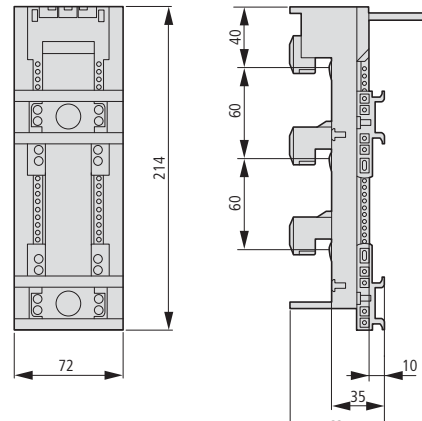

BBA2L-63

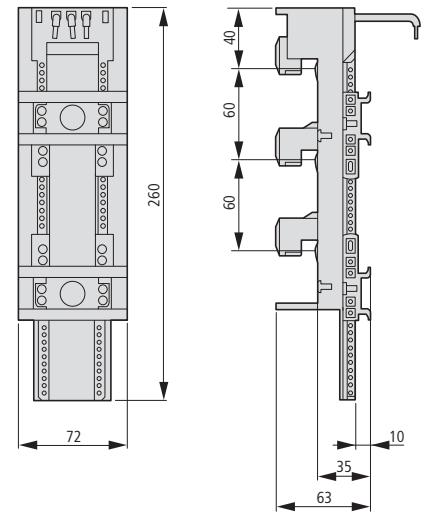

BBA0L-25

BBA0L-32

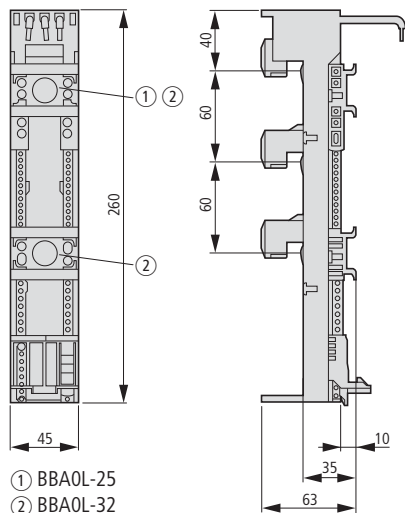

- ① BBA0L-25
- ② BBA0L-32

BBA0K-32

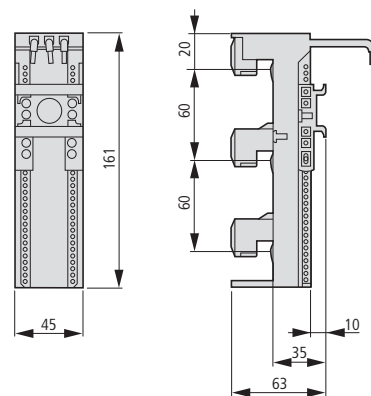

PKZM0-XC45L

PKZM0-XC45L-2

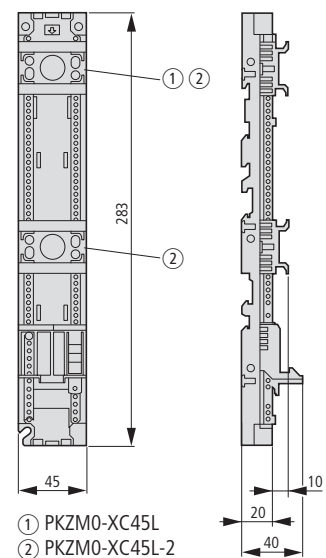

- ① PKZM0-XC45L
- ② PKZM0-XC45L-2

Insulated enclosures for surface mounting

CI-PKZ0-M

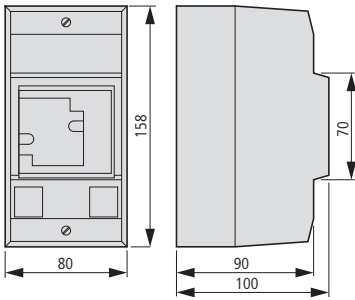

CI-PKZ10G...M

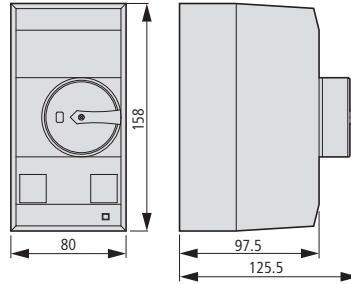

CI-PKZ0...M
+ SVB-PKZ0-CI

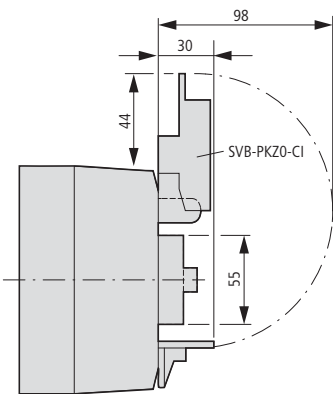

Drilling dimensions
CI-PKZ0...M

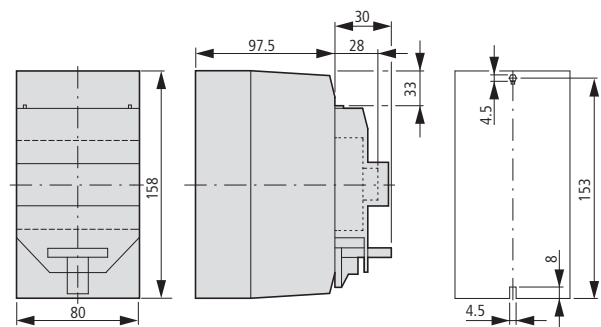

CI-K2-PKZ0

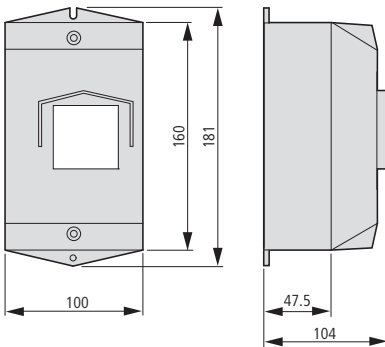

CI-K2-PKZ0G(R)(V)

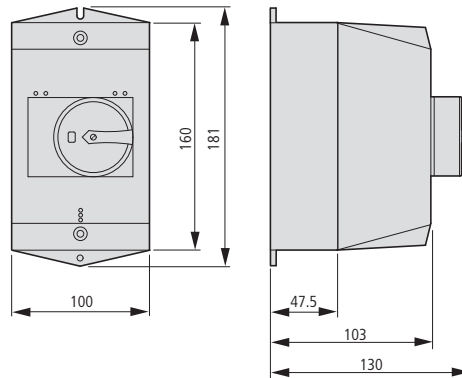

CI-K2-PKZ0-G(R)(V)
+ SVB-PKZ0-CI

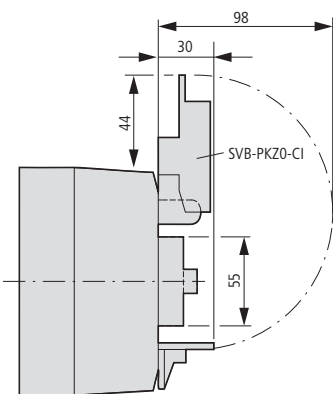

Drilling dimensions
CI-K2-PKZ0...

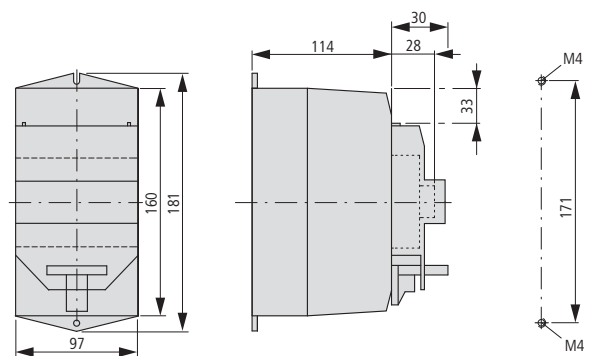

Door coupling handles

PKZ0-X(R)H...

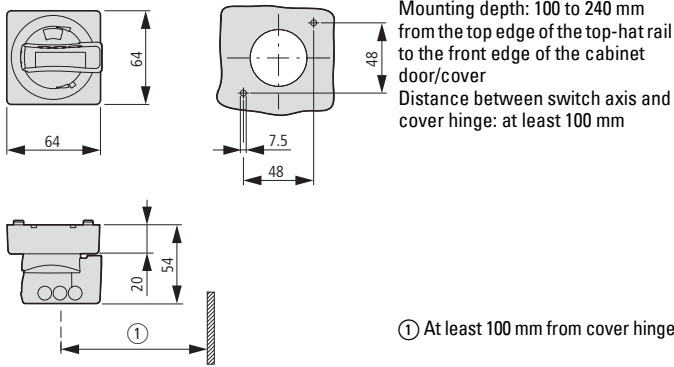

Insulated enclosures for flush mounting

E-PKZ0 E-PKZ0-G...

Mounting aperture E-PKZ0...

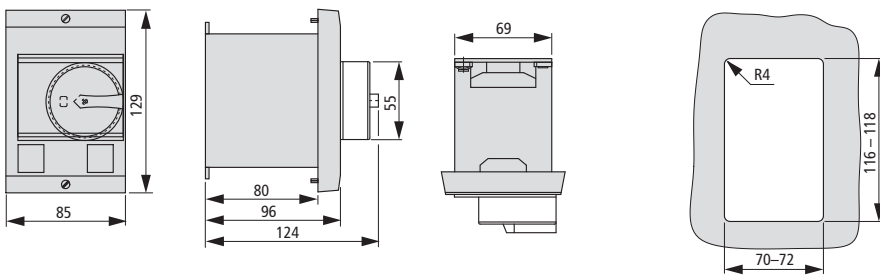

E-PKZ0-G... + SVB-PKZ0-E

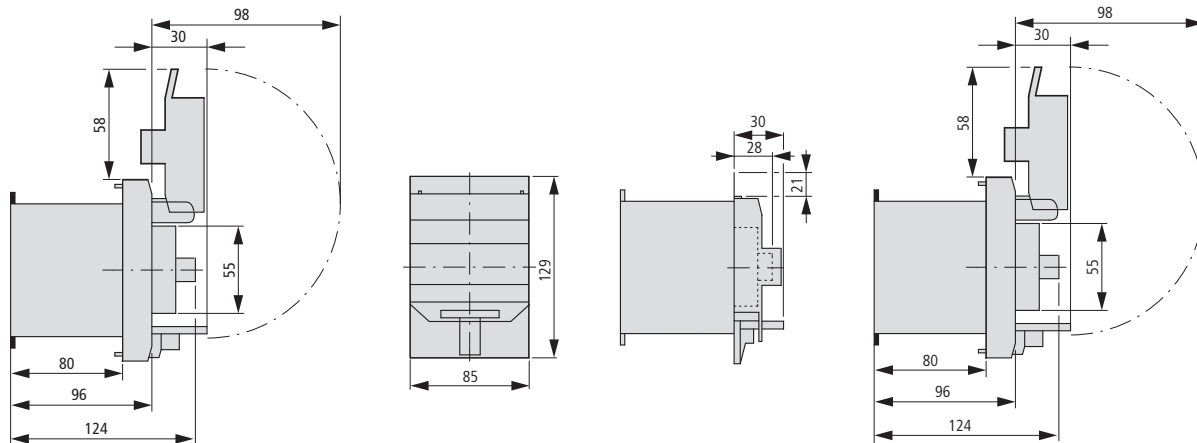

Insulated enclosures for surface mounting

CI23E...

Mounting plates

M3-CI23

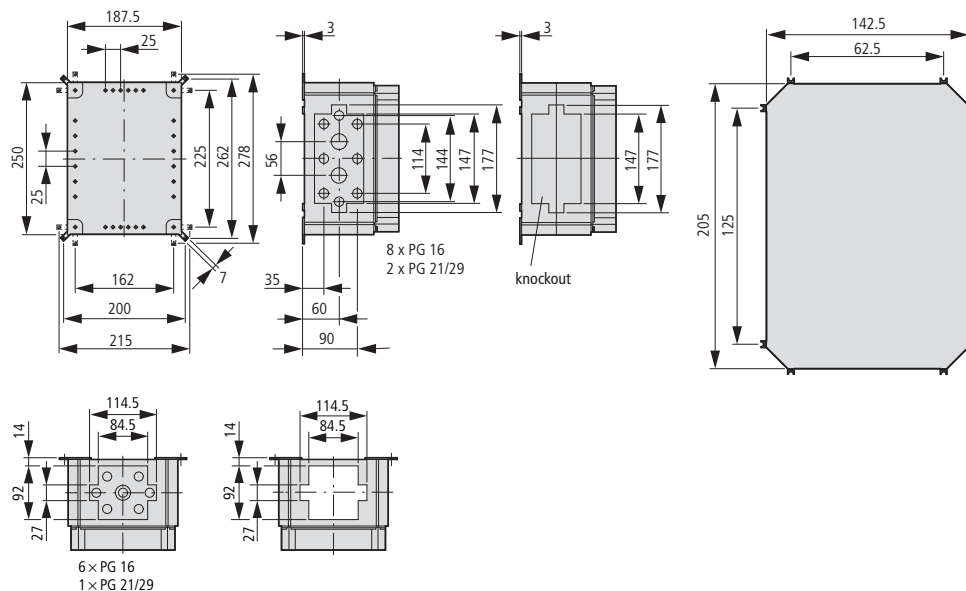

Insulated enclosures for surface mounting

CI-PKZ01
CI-PKZ01-G

CI-PKZ01-PVT
CI-PKZ01-PVS

CI-PKZ01-SVB
CI-PKZ01-SVB-V

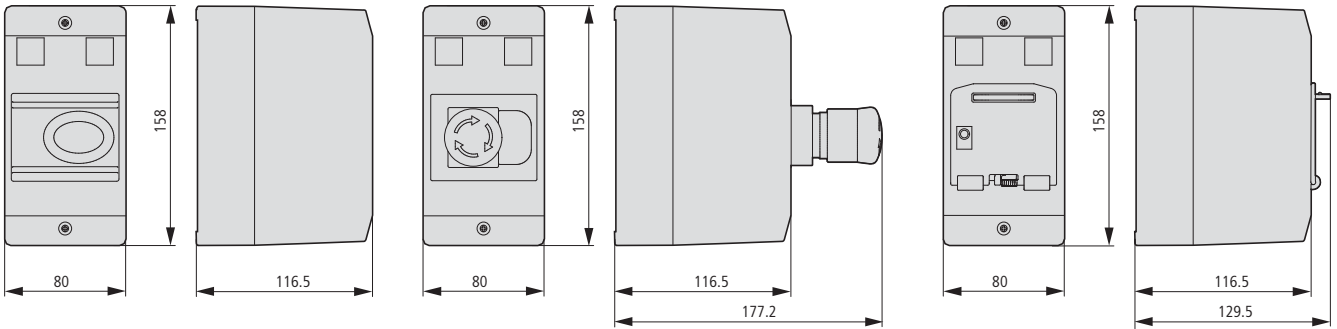

Insulated enclosures for flush mounting

E-PKZ01
E-PKZ01-G

E-PKZ01-PVT
E-PKZ01-PVS

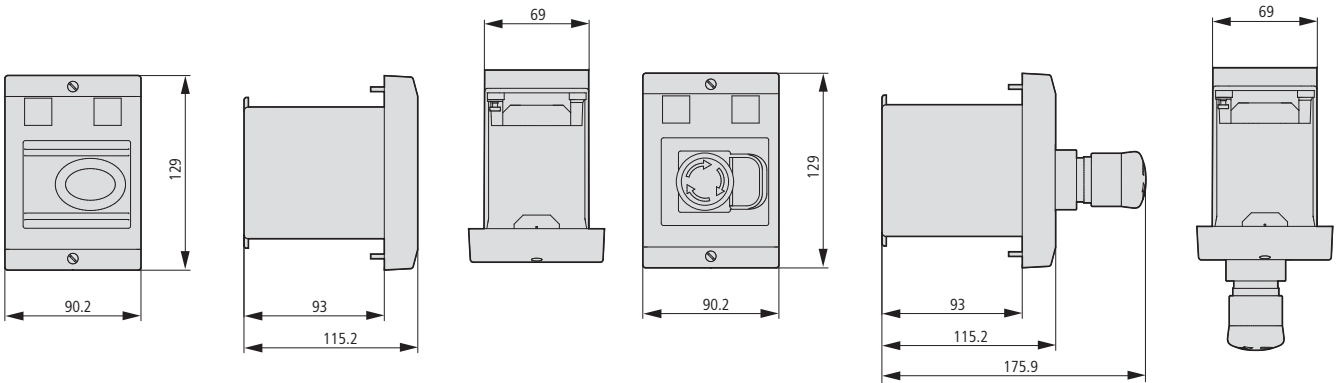

E-PKZ01-SVB
E-PKZ01-SVB-V

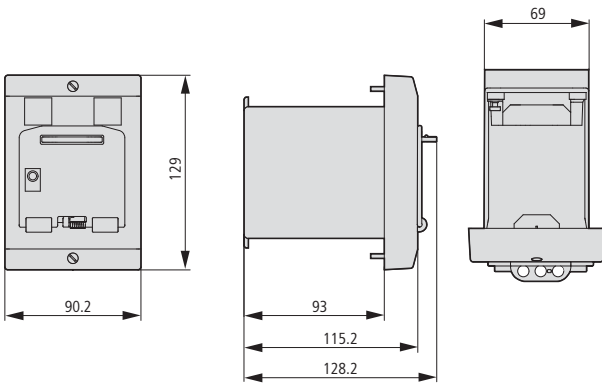

Motor-protective circuit-breaker

PKZM4-...

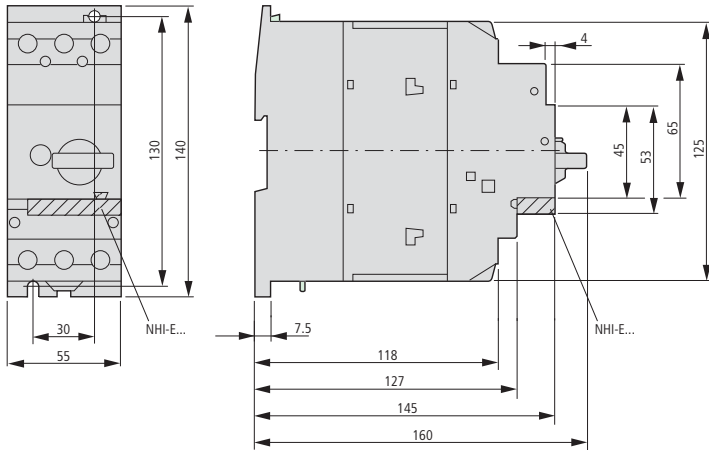

Standard auxiliary contacts

NHI...-PKZ...

NHI...-PKZ0

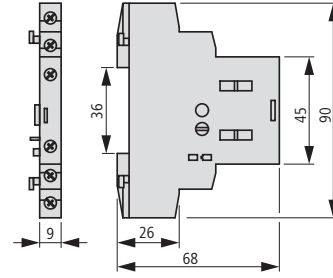

Motor-protective circuit-breakers with lockable cover

PKZM4-... +AK-PKZ0

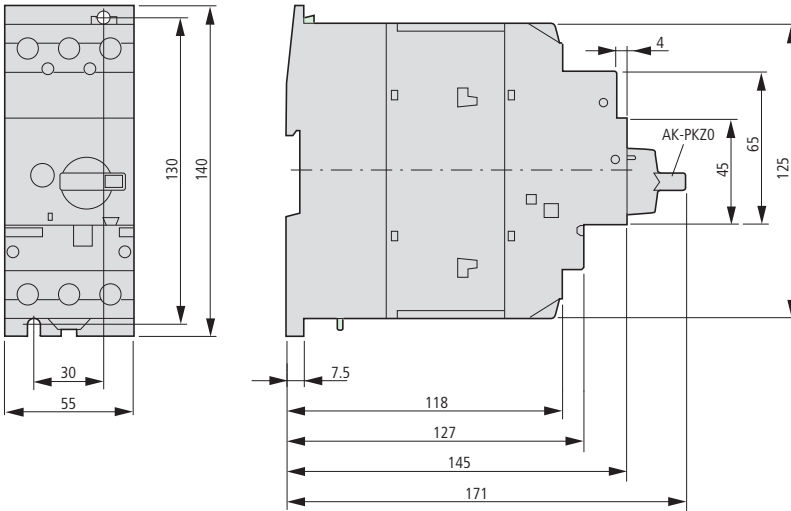

Trip indicators

AGM2...-PKZ...

AGM2...-PKZ0

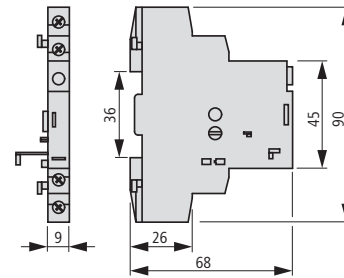

PKE Motor-protective circuit-breakers

PKE12, PKE32

PKE65

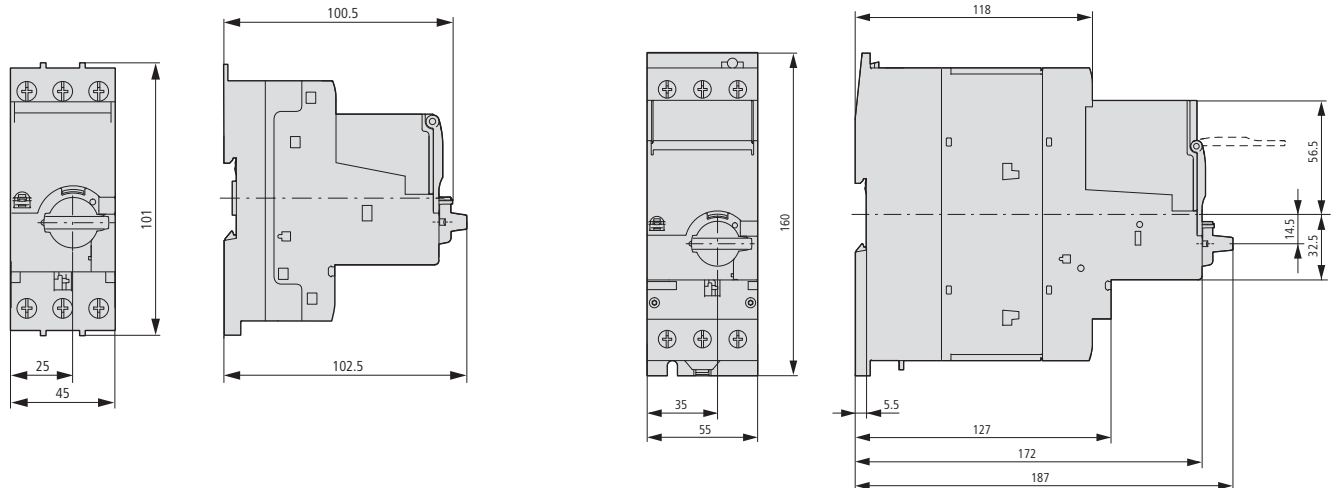

Three-phase commoning links

B3.0/4-PKZ4

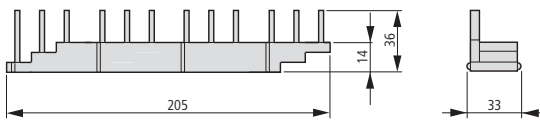

B3.2/4-PKZ4

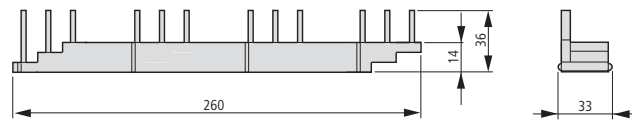

B3.0/3-PKZ4

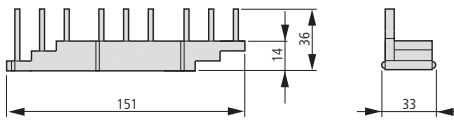

B3.2/2-PKZ4

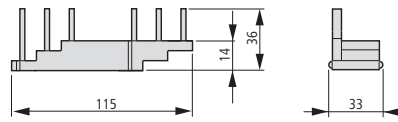

B3.0/2-PKZ4

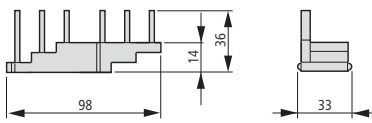

B3.1/3-PKZ4

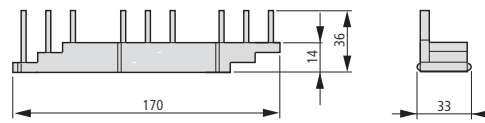

B3.1/4-PKZ4

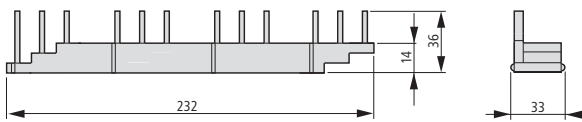

B3.1/2-PKZ4

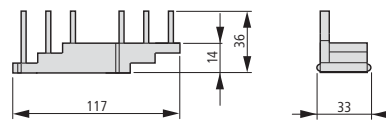

Three-phase commoning links

B3.0/4-PKZ0

B3.0/2-PKZ0

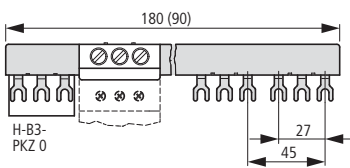

Three-phase commoning links

B3.2/4-PKZ0

B3.2/2-PKZ0

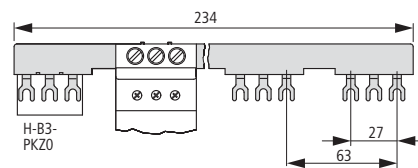

Three-phase commoning links

B3.1/5-PKZ0

B3.1/3-PKZ0

B3.1/4-PKZ0

B3.1/2-PKZ0

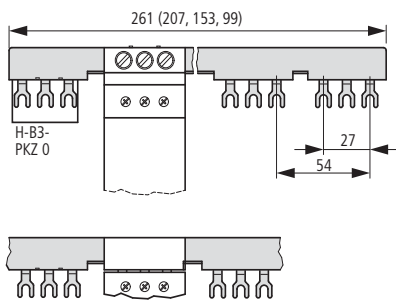

Incoming terminals

BK25/3-PKZ0

Overlapping mounting to extend the three-phase commoning link

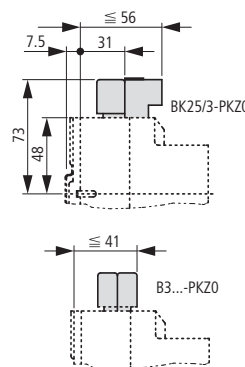

Motor plug DILM12-XMCP/T

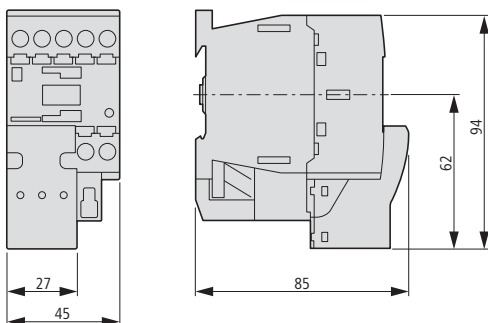

Insulated enclosures for surface mounting

CI-K4-PKZ4-G(R)

+SVB-PKZ4-CI

CI-K4-PKZ4-G

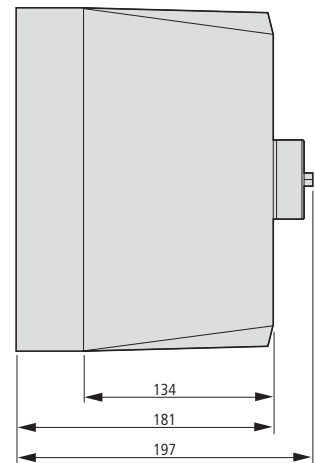
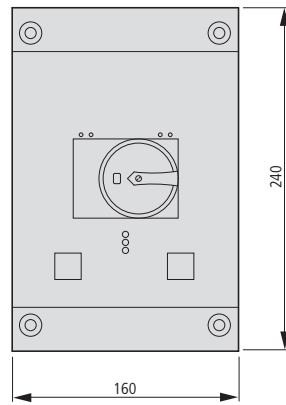
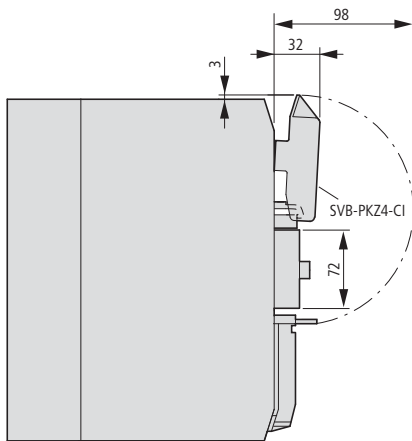

Drilling dimensions
CI-K4-PKZ4-G(R)

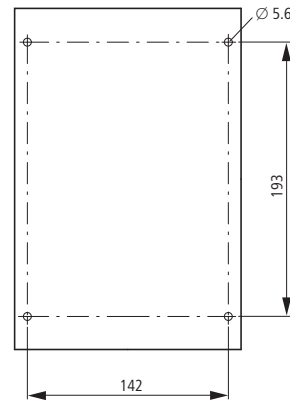
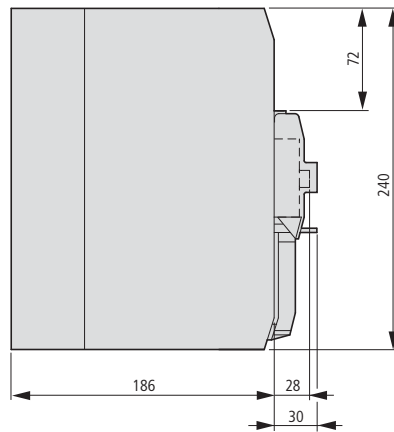
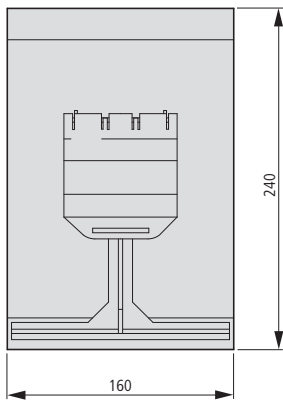

System overview

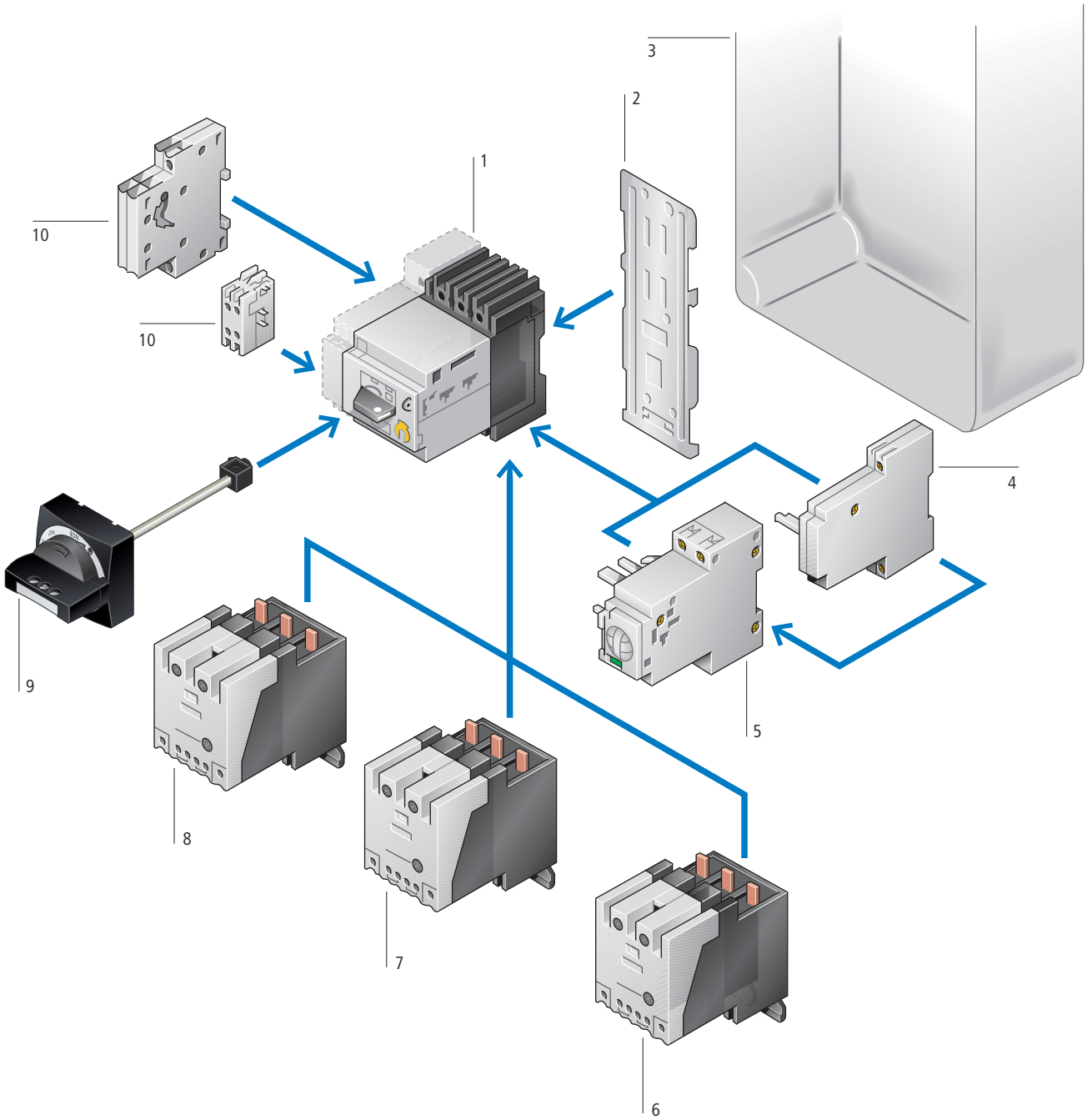

Basic devices

Motor-protective circuit-breakers	1
→ Page 7/48	
Circuit-breakers	1
→ Page 7/48	

Add-on functions

Contact modules	6
→ Page 7/64	
High-capacity contact modules	7
→ Page 7/64	
Auxiliary contacts	10
→ Page 7/58	

Current limiters	8
→ Page 7/58	
Shunt release	4
→ Page 7/60	
Remote operators	5
→ Page 7/62	

Mounting accessories

Mounting/wiring	2
→ Page 7/69	
Door coupling handles IP65	9
→ Page 7/57	
Insulated enclosures	3
→ Page 7/56	

Ordering

Max. motor rating		Rated uninterrupted current					Setting range	
AC-3		I_u					Overload releases	Short-circuit releases
220 V 230 V 240 V	380 V 400 V 415 V	440 V	500 V	690 V	A	I_r	I_{rm}	
P	P	P	P	P	A	A	A	
kW	kW	kW	kW	kW				

Motor-protective circuit-breakers, type of coordination "1" and "2"

	0.09	0.12	0.18	0.25	0.25	0.6	0.4...0.6	5...8
	0.12	0.25	0.25	0.37	0.55	1	0.6...1	8...14
	0.25	0.55	0.55	0.75	1.1	1.6	1...1.6	14...22
	0.37	0.75	1.1	1.1	1.5	2.4	1.6...2.4	20...35
	0.75	1.5	1.5	2.2	3	4	2.4...4	35...55
	1.1	2.2	3	3	4	6	4...6	50...80
	2.2	4	4	5.5	7.5	10	6...10	80...140
	4	7.5	9	9	12.5	16	10...16	130...220
	5.5	12.5	12.5	15	22	25	16...25	200...350
	7.5	15	17.5	22	22	32	24...32	275...425
	11	20	22	24	30	40	32...40	350...500

Circuit-breakers

For line and cable protection

	-	-	-	-	-	10	6...10	50...80
	-	-	-	-	-	16	10...16	80...140
	-	-	-	-	-	25	16...25	130...210
	-	-	-	-	-	32	24...32	160...280
	-	-	-	-	-	40	32...40	200...350

Notes

Information relevant for export to North America



Product Standards
UL File No.
UL CCN
CSA File No.
CSA Class No.
NA Certification
Suitable for
See also

UL 508; CSA-C22.2 No. 14; IEC60947-4-1; CE marking
E36332
NLRV
12528
3211-05
UL Listed, CSA certified
Branch circuit: as manual controller suitable for group installations
→ Page 7/75

Part no. Article no.	Price See price list	Std. pack	Notes	Notes	Notes
PKZ2/ZM-0.6 021859		1 off		Phase failure sensitivity to IEC/EN 60947-4-1, VDE 0660 Part 102.	Can be snap-fitted to IEC/EN 60715 top-hat rail with 7.5 or 15 mm height
PKZ2/ZM-1 026605			Adjustable overload release $I_r = 0.6 - 1.0 \times I_u$		
PKZ2/ZM-1.6 028978			Adjustable short-circuit release $I_{rm} = 8.5 - 14 \times I_u$ factory-set to $12 \times I_u$		
PKZ2/ZM-2.4 031351			PTB 02 ATEX 3152 Observe manual.		
PKZ2/ZM-4 033724					
PKZ2/ZM-6 036097					
PKZ2/ZM-10 038470					
PKZ2/ZM-16 040843					
PKZ2/ZM-25 043216					
PKZ2/ZM-32 045589					
PKZ2/ZM-40 047962					
PKZ2/ZM-10-8 050335		1 off	Adjustable overload release $I_r = 0.6 - 1.0 \times I_u$	Can be snap-fitted to IEC/EN 60715 top-hat rail with 7.5 or 15 mm height	
PKZ2/ZM-16-8 052708			Adjustable short-circuit release $I_{rm} = 5.0 - 8.5 \times I_u$ factory-set to $5 \times I_u$		
PKZ2/ZM-25-8 055081					
PKZ2/ZM-32-8 057454					
PKZ2/ZM-40-8 059827					

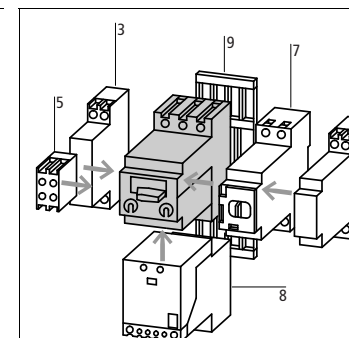

Accessories	Page
3 Standard auxiliary contacts	→ 7/58
5 Trip-indicating auxiliary contact	→ 7/58
6 Shunt releases, undervoltage releases	→ 7/60
7 Remote operators	→ 7/62
8 Contact module, high-capacity contact modules, current limiters	→ 7/64
9 Clip plate	→ 7/69
Additional accessories	→ 7/56
Rated ultimate short-circuit breaking capacity	→ 7/78
Manual	→ 7/69

Max. motor rating						Rated uninterrupted current I_u A	Setting range	
AC-3		AC-3		AC-3			Overload releases I_r	Short-circuit releases I_{rm}
220 V 230 V 240 V	380 V 400 V 415 V	440 V	500 V	660 V 690 V		A	A	
P	P	P	P	P		A	A	
kW	kW	kW	kW	kW				

Compact starters, type "1" coordination

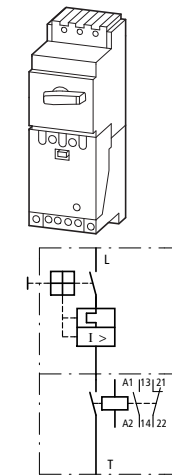

0.12	0.25	0.25	0.37	0.55	1	0.6...1	8...14
0.25	0.55	0.55	0.75	1.1	1.6	1...1.6	14...22
0.37	0.75	1.1	1.1	1.5	2.4	1.6...2.4	20...35
0.75	1.5	1.5	2.2	3	4	2.4...4	35...55
1.1	2.2	3	3	4	6	4...6	50...80
2.2	4	4	5.5	7.5	10	6...10	80...140
4	7.5	9	9	12.5	16	10...16	130...220
5.5	12.5	12.5	15	22	25	16...25	200...350
7.5	15	17.5	22	22	32	24...32	275...425
11	18.5	22	24	30	36	32...40	350...500

High-capacity compact starters, type "2" coordination

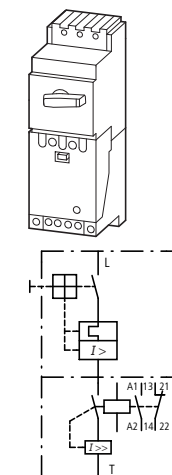

0.12	0.25	0.25	0.37	0.55	1	0.6...1	8...14
0.25	0.55	0.55	0.75	1.1	1.6	1...1.6	14...22
0.37	0.75	1.1	1.1	1.5	2.4	1.6...2.4	20...35
0.75	1.5	1.5	2.2	3	4	2.4...4	35...55
1.1	2.2	3	3	4	6	4...6	50...80
2.2	4	4	5.5	7.5	10	6...10	80...140
4	7.5	9	9	12.5	16	10...16	130...220
5.5	12.5	12.5	15	22	25	16...25	200...350
7.5	15	17.5	22	22	32	24...32	275...425
11	18.5	22	24	30	36	32...40	350...500

Notes

Information relevant for export to North America



Product Standards
UL File No.
UL CCN
CSA File No.
CSA Class No.
NA Certification
Suitable for
See also

IEC/EN 60947-4-1; UL 508; CSA-C22.2 No. 14-05; CE marking
E36332
NLRV
012528
3211-05
UL Listed, CSA certified
Branch circuit: as manual controller with contactor, suitable for group installations
→ Page 7/75



Part no. Article no.	Price See price list	Std. pack	Notes	Notes
PKZ2/ZM-1/SE1A/11(230V50HZ,240V60HZ) 063364		1 off	1 NC and 1 N/O auxiliary contact built into the contact module.	<p>Accessories</p> <p>3 Standard auxiliary contacts → 7/58</p> <p>4 Standard auxiliary contacts → 7/58</p> <p>5 Trip-indicating auxiliary contact → 7/58</p> <p>6 Shunt release, undervoltage release → 7/60</p> <p>7 Remote operators → 7/62</p> <p>9 Clip plate → 7/69</p> <p>Additional accessories → 7/56</p> <p>Further actuating voltages → 7/70</p> <p>Manual → 7/69</p> <p>Phase failure sensitivity to IEC/EN 60947-4-1, VDE 0660 Part 102</p> <p>Supplied ready mounted on clip plate C-PKZ2, can be snap-fitted to one or two IEC/EN 60715 top-hat rails, height 15 mm</p> <p>Overload releases adjustable $I_r = 0.6 - 1.0 \times I_u$</p> <p>Adjustable short-circuit release $I_{rm} = 8.5 - 14 \times I_u$ factory-set to $12 \times I_u$</p> <p> PTB 02 ATEX 3152</p> <p>Observe manual.</p> <p>The compact starters consist of a motor-protective circuit-breaker, which features a plug-in trip block and an attached contact module with the same matching profile. The devices are prefitted to a clip plate and can be snap-fitted, as a unit, centrally onto one or two top-hat rails to IEC/EN 60715 conform top-hat rails.</p> <p>They conform with IEC/EN 60947-4-1, VDE 0660 Part 102.</p> <p>I_q = Rated conditional short-circuit current</p>
PKZ2/ZM-1.6/SE1A/11(230V50HZ,240V60HZ) 063372				
PKZ2/ZM-2.4/SE1A/11(230V50HZ,240V60HZ) 063382				
PKZ2/ZM-4/SE1A/11(230V50HZ,240V60HZ) 063392				
PKZ2/ZM-6/SE1A/11(230V50HZ,240V60HZ) 063402				
PKZ2/ZM-10/SE1A/11(230V50HZ,240V60HZ) 063412				
PKZ2/ZM-16/SE1A/11(230V50HZ,240V60HZ) 063422				
PKZ2/ZM-25/SE1A/11(230V50HZ,240V60HZ) 063432				
PKZ2/ZM-32/SE1A/11(230V50HZ,240V60HZ) 063442				
PKZ2/ZM-40/SE1A/11(230V50HZ,240V60HZ) 063452				
PKZ2/ZM-1/S(230V50HZ,240V60HZ) 063472		1 off	Rated short-circuit current $I_q = 100 \text{ kA}/400 \text{ V}$ High-capacity contact module has built-in auxiliary contacts: 1 M/1 B	
PKZ2/ZM-1.6/S(230V50HZ,240V60HZ) 063482				
PKZ2/ZM-2.4/S(230V50HZ,240V60HZ) 063492				
PKZ2/ZM-4/S(230V50HZ,240V60HZ) 063502				
PKZ2/ZM-6/S(230V50HZ,240V60HZ) 063512				
PKZ2/ZM-10/S(230V50HZ,240V60HZ) 063522				
PKZ2/ZM-16/S(230V50HZ,240V60HZ) 063532				
PKZ2/ZM-25/S(230V50HZ,240V60HZ) 063542				
PKZ2/ZM-32/S(230V50HZ,240V60HZ) 063552				
PKZ2/ZM-40/S(230V50HZ,240V60HZ) 063562				





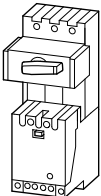

	Rated uninterrupted current I_u A	Part no. Article no.	Price See price list	Std. pack	Information relevant for export to North America
Basic device, 3 poles, motor and system protection					
	40	PKZ2 026606		1 off 	 Circuit for ZM...PKZ2(4) M...PKZ2(4)
Basic device, 3 pole, motor protection					
	40	PKZ2/S(230V50HZ, 240V60HZ) 063572		1 off 	 ZMR...PKZ2
	40	PKZ2/SE1A/11(230V50HZ, 240V60HZ) 082142		1 off	<p>Adjustable: H Δ manual position or A Δ automatic position</p> <p>For EEx e applications the 95/96 break contact must always be used to de-energize the (high-capacity) contact module or contactor.</p> <p>Motor-protective trip blocks ZMR...-PKZ2 cannot be combined with U/A voltage releases and RE/RS remote operators.</p> <p>Further actuating voltages → Page 7/70 Manual → Page 7/69</p>
Basic device, 4 poles, system protection					
	40	PKZ24 004521		1 off	

Information relevant for export to North America

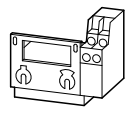

Product Standards	UL 508; CSA-C22.2 No. 14; IEC60947-4-1; CE marking
UL File No.	E36332
UL CCN	NLRV
CSA File No.	12528
CSA Class No.	3211-05
NA Certification	UL Listed, CSA certified

Maximum motor rating AC	Rated short-circuit breaking capacity I_{cn}	Part no. Article no.	Price See price list	Std. pack	Information relevant for export to North America
200 V 230 V 460 V 575 V HP HP HP HP	240 V 480 V 600 V AC AC AC kA kA kA				
Basic device					
In connection with motor-protective trip blocks ZM-...PKZ2 → Page 7/70 The values given are maximum values, depending on the trip block					
					
DOL starter					
10 15 30 25 100 65 42		PKZ2/S-SP (110V50HZ,120V60HZ) 050940		1 off 	Product Standards UL 508; CSA-C22.2 No. 14; IEC60947-4-1; CE marking UL File No. E123500 UL CCN NKJH NA Certification UL Listed, CSA certified Suitable for Branch circuit: as Type E self- protected combination motor controller See also TB_PKZ2_PRO_Netze_NA
Reversing starters					
10 15 30 25 100 65 42		PKZ2-SP-FVR(*V*HZ) 925109		1 off 	Product Standards UL 508; CSA-C22.2 No. 14; IEC60947- 4-1; CE marking UL File No. E123500 UL CCN NKJH CSA File No. 12528 CSA Class No. 3211-06 NA Certification UL Listed, CSA certified Specially designed for NAYes Suitable for Branch circuit: as Reversing Type E self-protected combination motor controller See also TB_PKZ2_PRO_Netze_NA
Notes					
Specify actuating voltage in the range 24 – 600 V 50 or 60 Hz. Application: Mains supply up to 27 A 600 Y/347 V AC 480 Y/277 V AC 27 – 42 A 480 Y/277 V AC Service factor (SF) Set value I_r on the current scale, depending on the load factor $SF = 1.15 \rightarrow I_r = 1 \times I_{n \text{ mot}}$ $SF = 1 \rightarrow I_r = 0.9 \times I_{n \text{ mot}}$ Terminal capacities, high-capacity compact starters PKZ2/ZM.../S Main terminals Cables Cu 75 °C, min. AWG 14, max. AWG 6 Torque 1.8 Nm Control circuit terminals Cables min. AWG 20, max. AWG 16 (0.5–1 mm ²) With insulated/uninsulated blade terminal, nominal size 2.8					

Max. motor rating						Rated uninter- rupted current	Setting range		Part no. Article no.	Price See price list	Std. pack	Notes
AC-3					I_u		Overload releases	Short-circuit releases				
220 V	380 V	440 V	500 V	660 V		A	I_r	I_{rm}				
230 V	400 V			690 V								
240 V	415 V											
P	P	P	P	P	A	A	A					
kW	kW	kW	kW	kW								
Motor-protective trip blocks, 3 pole												
With overload release												
	0.09	0.12	0.18	0.25	0.25	0.6	0.4...0.6	5...8	ZM-1,6-PKZ2 024232	1 off  	Phase failure sensitivity to IEC/EN 60947-4-1, VDE 0660 Part 102	
	0.12	0.25	0.25	0.37	0.55	1	0.6...1	8...14	ZM-1-PKZ2 028979			
	0.25	0.55	0.55	0.75	1.1	1.6	1...1.6	14...22	ZM-1,6-PKZ2 031352			
	0.37	0.75	1.1	1.1	1.5	2.4	1.6...2.4	20...35	ZM-2,4-PKZ2 033725			
	0.75	1.5	1.5	2.2	3	4	2.4...4	35...55	ZM-4-PKZ2 036098			
	1.1	2.2	3	3	4	6	4...6	50...80	ZM-6-PKZ2 038471			
	2.2	4	4	5.5	7.5	10	6...10	80...140	ZM-10-PKZ2 040844			
	4	7.5	9	9	12.5	16	10...16	130...220	ZM-16-PKZ2 043217			
	5.5	12.5	12.5	15	22	25	16...25	200...350	ZM-25-PKZ2 045590			
	7.5	15	17.5	22	22	32	24...32	275...425	ZM-32-PKZ2 047963			
11	20	22	24	30	40	32...40	350...500	ZM-40-PKZ2 050336				
With overload/relay function, with manual/automatic position												
	0.09	0.12	0.18	0.25	0.25	0.6	0.4...0.6	5...8	ZMR-0,6-PKZ2 033943	1 off  	Phase failure sensitivity, adjustability and  as ZM blocks.	
	0.12	0.25	0.25	0.37	0.55	1	0.6...1	8...14	ZMR-1-PKZ2 033950			
	0.25	0.55	0.55	0.75	1.1	1.6	1...1.6	14...22	ZMR-1,6-PKZ2 033952			
	0.37	0.75	1.1	1.1	1.5	2.4	1.6...2.4	20...35	ZMR-2,4-PKZ2 033955			
	0.75	1.5	1.5	2.2	3	4	2.4...4	35...55	ZMR-4-PKZ2 033957			
	1.1	2.2	3	3	4	6	4...6	50...80	ZMR-6-PKZ2 033966			
	2.2	4	4	5.5	7.5	10	6...10	80...140	ZMR-10-PKZ2 033967			
	4	7.5	9	9	12.5	16	10...16	130...220	ZMR-16-PKZ2 033968			
	5.5	12.5	12.5	15	22	25	16...25	200...350	ZMR-25-PKZ2 033969			
	7.5	15	17.5	22	22	32	24...32	275...425	ZMR-32-PKZ2 033973			
11	20	22	24	30	40	32...40	350...500	ZMR-40-PKZ2 033975				

Notes





Information relevant for export to North America

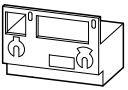

Product Standards	UL 508; CSA-C22.2 No. 14; IEC60947-4-1; CE marking
UL File No.	E36332
UL CCN	NLRV
CSA File No.	12528
CSA Class No.	3211-05
NA Certification	UL Listed, CSA certified
See also	HPL2007/2008_17/36

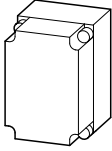
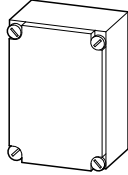
Max. motor rating AC-3	Rated uninter- rupted current					Setting range Overload releases Short-circuit releases	Part no. Article no.	Price See price list	Std. pack	Notes																			
	220 V	380 V	440 V	500 V	660 V						I_u	I_r	I_{rm}																
	230 V	400 V			690 V																								
	240 V	415 V																											
P	P	P	P	P	P	I_u	I_r	I_{rm}																					
kW	kW	kW	kW	kW	kW	A	A	A																					
Without overload release																													
	-	-	-	-	-	0.6		5...8	M-0,6-PKZ2 004537	1 off	Adjustable short-circuit release $I_{rm} = 8.5 - 14 \times I_u$ Factory set to $12 \times I_u$ When using the M-...-PKZ2 as a short-circuit protective device for motors with heavy starting duty, rated operational current I_e must be overspecified with the following factors when designing the switchgear:																		
	-	-	-	-	-	1		8...14	M-1-PKZ2 004538																				
	-	-	-	-	-	1.6		14...22	M-1,6-PKZ2 004539																				
	-	-	-	-	-	2.4		20...35	M-2,4-PKZ2 004540																				
	-	-	-	-	-	4		35...55	M-4-PKZ2 004541																				
	-	-	-	-	-	6		50...80	M-6-PKZ2 004542																				
	-	-	-	-	-	10		80...140	M-10-PKZ2 004543																				
	-	-	-	-	-	16		130...220	M-16-PKZ2 004544																				
	-	-	-	-	-	25		200...350	M-25-PKZ2 004545																				
	-	-	-	-	-	32		275...425	M-32-PKZ2 004546																				
	-	-	-	-	-	40		350...500	M-40-PKZ2 004547																				
														<table border="1"> <thead> <tr> <th>CLASS</th> <th>Factor</th> </tr> </thead> <tbody> <tr><td>5</td><td>1.0</td></tr> <tr><td>10</td><td>1.0</td></tr> <tr><td>15</td><td>1.22</td></tr> <tr><td>20</td><td>1.41</td></tr> <tr><td>25</td><td>1.58</td></tr> <tr><td>30</td><td>1.73</td></tr> <tr><td>35</td><td>1.89</td></tr> <tr><td>40</td><td>2.0</td></tr> </tbody> </table>	CLASS	Factor	5	1.0	10	1.0	15	1.22	20	1.41	25	1.58	30	1.73	35
CLASS	Factor																												
5	1.0																												
10	1.0																												
15	1.22																												
20	1.41																												
25	1.58																												
30	1.73																												
35	1.89																												
40	2.0																												

Rated uninter- rupted current I_u	Setting range		Part no. Article no.	Price See price list	Std. pack	Notes
	Overload releases I_r	Short-circuit releases I_{rm}				
A	A	A				
Trip blocks for system protection						
3 pole						
With overload release						
	10	6...10	50...80	ZM-10-8-PKZ2 062201	1 off	Adjustable overload release $I_r = 0.6 - 1.0 \times I_u$ Adjustable short-circuit release $I_{rm} = 5 - 8.5 \times I_u$ factory-set to $5 \times I_u$
	16	10...16	80...140	ZM-16-8-PKZ2 059828		
	25	16...25	130...210	ZM-25-8-PKZ2 057455		
	32	24...32	160...280	ZM-32-8-PKZ2 055082		
	40	32...40	200...350	ZM-40-8-PKZ2 052709		
4 pole						
With overload releases in all 4 poles						
	10	6...10	50...80	ZM-10-8-PKZ24 004526	1 off	Adjustable overload release $I_r = 0.6 - 1.0 \times I_u$ Adjustable short-circuit release $I_{rm} = 5 - 8.5 \times I_u$ factory-set to $5 \times I_u$ Circuit-breakers PKZ24/ZM-...-8 protect 4 poles
	16	10...16	80...140	ZM-16-8-PKZ24 004525		
	25	16...25	130...210	ZM-25-8-PKZ24 004524		
	32	24...32	160...280	ZM-32-8-PKZ24 004523		
	40	32...40	200...350	ZM-40-8-PKZ24 004522		

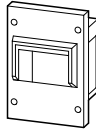





		For use with	Part no. Article no.	Price See price list	Std. pack	Notes
Insulated enclosures for surface mounting						
For motor-protective circuit-breakers, 3 or 4 pole circuit-breaker						
	Degree of protection IP40, cover with aperture dimensioned to accommodate front of breaker incl. blanking strip	PKZ2/ZM-... +NHI + AGM + U or A and RE or RS PKZ24/ZM-... + NHI + AGM + U or A	CI19EA-PKZ2 026234		1 off	Integrated IEC/EN 60715 top-hat rail, separate terminals for PE(N) and N connection
	Degree of protection IP54 prepared for mounting of a PKZ2-X(R)H-CI rotary handle	PKZ2/ZM-... + NHI + AGM + U or A + (R)H	CI19EB-PKZ2 028607		1 off	Incl. cable entries 2 x PG 16/21/29
	Degree of protection IP54 prepared for mounting of a PKZ2-X(R)H-CI rotary handle	PKZ24/ZM-... + NHI + AGM + U or A + (R)H	CI19ED-PKZ24 005145		1 off	Indicator light L-PKZ0 be fitted
For 3 pole compact starter, high-capacity compact starter, combination circuit-breakers						
	Degree of protection IP40, cover with aperture dimensioned to accommodate front of breaker incl. blanking strip	PKZ2/ZM-.../S(E1A) + NHI + AGM + RE or RS and U or A	CI23EA-PKZ2 087936		1 off	Mounting plate L3/5-CI23 integrated
	Degree of protection IP54 prepared for mounting of a PKZ2-X(R)H-CI rotary handle	PKZ2/ZM-.../S + NHI + AGM + U or A + (R)H	CI23EB-PKZ2 090309		1 off	Prepared for a compact starter or a High-capacity compact starters PKZ2/ZM-.../S without fitted clip plate
Insulated enclosure for motor-protective circuit breakers PKZ2/ZM						
Degree of protection NEMA 12						
	Prepared for mounting a door coupling handle PKZ2-X(R)H	–	CI19EE-PKZ2-NA¹⁾ 003183		1 off  	Integrated IEC/EN 60715 top-hat rail, for connecting installation pipes and end-to-end earthing Not for use with PKZ2/ZM...S(-SP)
	With mounting plate without apertures	–	CI19E-125/M-NA²⁾ 033451		1 off  	For connection of conduit and continuous earthing Not for use with PKZ2/ZM...S(-SP)
Insulated enclosures for flush mounting						
For motor-protective circuit-breakers, 3 or 4 pole circuit-breaker						
	IP41 degree of protection, grey front plate with retaining frame, integral PE(N) terminal	PKZ2/ZM-... + NHI + AGM PKZ2/ZM-... +U or A (undervoltage or shunt release) PKZ24/ZM-...	E-PKZ2 003218		1 off	For side-wall or door mounting Vertical mounting position Indicator light L-PKZ0 can be fitted
	For degree of protection IP54, door coupling rotary handle PKZ2-X(R)H always required in addition	PKZ2/ZM-... + NHI + AGM PKZ2/ZM-... +U or A (undervoltage or shunt release) PKZ24/ZM-...	E54-PKZ2 033939		1 off	For side-wall or door mounting Vertical mounting position Indicator light L-PKZ0 can be fitted

Information relevant for export to North America

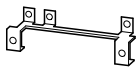
1)	Product Standards	UL 508; CSA-C22.2 No. 14; IEC60947-4-1; CE marking
	UL File No.	E36332
	UL CCN	NLRV
	CSA File No.	12528
	CSA Class No.	3211-05
	NA Certification	UL Listed, CSA certified
	Specially designed for NA	✓
	Degree of Protection	IEC: -, UL/CSA Type: 12
	See also	HPL2007/2008_17/36

2)	Product Standards	UL 508; CSA-C22.2 No. 14; IEC60947-4-1; CE marking
	UL File No.	On request
	UL CCN	On request
	CSA File No.	12528
	CSA Class No.	3211-05
	NA Certification	UL Listed, CSA certified
	Specially designed for NA	✓
	Degree of Protection	IEC: -, UL/CSA Type: 12
	See also	HPL2007/2008_17/36

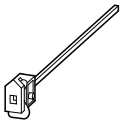
HPL07057EN

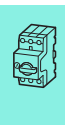

	Color	Part no. Article no.	Price See price list	Std. pack	Notes	Information relevant for export to North America 
Neutral terminal						
For connecting a 5th conductor in enclosure E-PKZ2, E54-PKZ2						
	–	–	N-PKZ2 003219	1 off	–	
Door coupling handles						
Degree of protection IP65 / UL/CSA Type 4X/Type 12						
	For use as main switch to EN 60204	Black	PKZ2-XH 106127	1 off 	Lockable in 0-position Suitable for 3 padlocks with 4 – 8 mm hasp thickness	Product Standards UL 508; CSA-C22.2 No. 14; IEC60947-4-1; CE marking E36332 UL File No. NLRV UL CCN 12528 CSA File No. 3211-05 NA Certification UL Listed, CSA certified
	For use in MCC distribution boards with PKZ2 turned through 90°. For use as main switch according to EN 60204	Black	PKZ2-XH-MCC 106130	1 off 		
	For use as a main switch with emergency switching off function to EN 60204	Red-yellow	PKZ2-XRH 106128	1 off 		
Plug-in extension shaft for door coupling handle						
Can be cut to any required length for mounting depths from 171 – 300 mm						
	–	–	PKZ2-XAH 106129	1 off 	–	Product Standards UL 508; CSA-C22.2 No. 14; IEC60947-4-1; CE marking E36332 UL File No. NLRV UL CCN 12528 CSA File No. 3211-05 NA Certification UL Listed, CSA certified
Rotary handle for insulated enclosures CI19(23)...-PKZ2						
	–	Black	PKZ2-XH-CI 138580	1 off	–	
	–	Red-yellow	PKZ2-XRH-CI 138581	1 off	–	



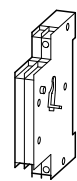
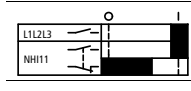
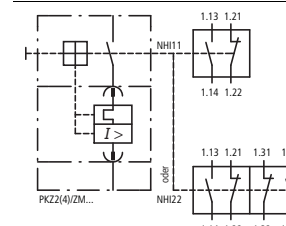

Contact configuration	Contact sequence	Circuit diagrams
N/O = normally open contact NC = normally closed contact		

Standard auxiliary contacts¹

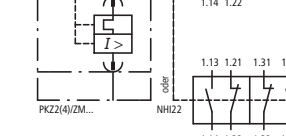
For motor-protective circuit-breaker, circuit-breakers and (high-capacity) compact starters

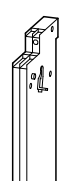
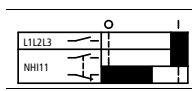
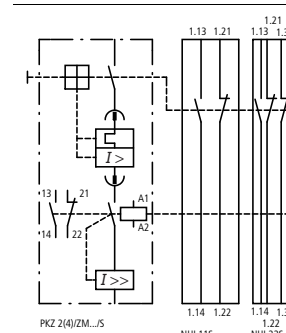
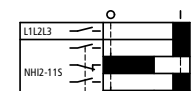
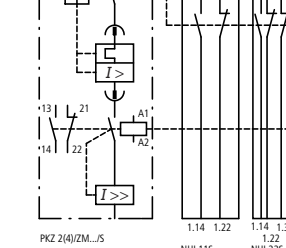

	1 N/O	1 NC		
	2 N/O	2 NC		

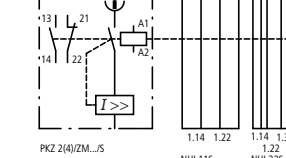
For compact starters

	1 N/O	1 NC		
	2 N/O	2 NC		
	2 x 1 N/O	2 x 1 NC		

Trip indicating auxiliary contacts with short-circuit indicator²

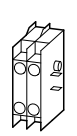
For motor-protective circuit-breaker, circuit-breakers and (high-capacity) compact starters

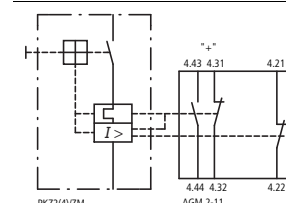
	2 x 1 N/O	2 x 1 NC		
------------------------------------------------------------------------------------	-----------	----------	------------------------------------------------------------------------------------	-------------------------------------------------------------------------------------

Short-circuit indicators²

For motor-protective circuit-breaker, circuit-breakers and (high-capacity) compact starters

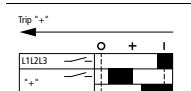
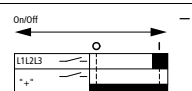
				
-------------------------------------------------------------------------------------	--	--	-------------------------------------------------------------------------------------	-------------------------------------------------------------------------------------

Current limiters

Increase the switching capacity of non auto-protected motor-protective circuit-breakers to 100 kA/500 V

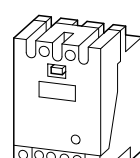
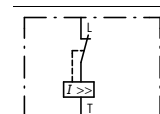
			
-------------------------------------------------------------------------------------	--	--	--------------------------------------------------------------------------------------

Information relevant for export to North America



1)	2)
Product Standards UL 508; CSA-C22.2 No. 14; IEC60947-4-1; CE marking	Product Standards UL 508; CSA-C22.2 No. 14; IEC60947-4-1; CE marking
UL File No. E29184	CSA File No. 1017555
UL CCN NKCR	CSA Class No. 3211-05
CSA File No. 12528	NA Certification UL Listed, CSA certified
CSA Class No. 3211-05	
NA Certification UL Listed, CSA certified	

Part no. Article no.	Price See price list	Std. pack	Notes	Notes
-------------------------	-------------------------	-----------	-------	-------

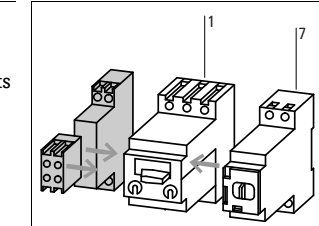
NHI11-PKZ2 090677		1 off	Can be fitted to circuit-breakers and (high-capacity) compact starters.	
NHI22-PKZ2 097796		1 off	Can be combined with trip-indicating auxiliary contacts AGM	

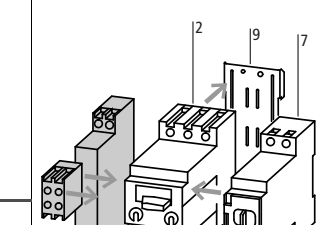
NHI11S-PKZ2 007623		1 off	Can be fitted to starter combinations	
NHI22S-PKZ2 000504		1 off	Can be combined with AGM trip-indicating auxiliary contacts	
NHI2-11S-PKZ2 009996		1 off		

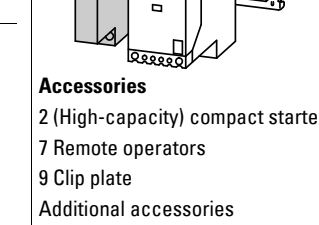
AGM2-11-PKZ2 017115		1 off	Differential remote indication: a) General trip indication "+", overload, b) Short-circuit releases	
			Can be fitted to circuit-breakers and (high-capacity) compact starters, Can be combined with standard auxiliary contacts NHI... or NHI...S	

K-AGM-PKZ2 021861		5 off	Local short-circuit indication by indicator, can be reset. Can be used in circuit-breakers and (high-capacity) compact starters	
-----------------------------	--	-------	------------------------------------------------------------------------------------------------------------------------------------	--

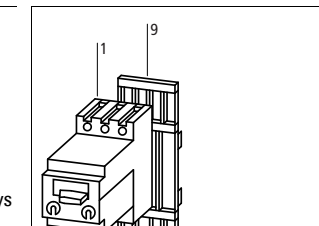

CL-PKZ2 076439		1 off	Max. rated operating voltage $U_e = 690$ V Rated uninterrupted current $I_u = 40$ A Can be retrofitted to circuit-breaker or separately positioned with EZ base Can be used for individual protection When fitting to circuit-breaker, clip plate C-PKZ2 always required	
--------------------------	--	-------	--------------------------------------------------------------------------------------------------------------------------------------------------------------------------------------------------------------------------------------------------------------------------------------------------	---------------------------------------------------------------------------------------

Accessories	Page
1 Motor-protective circuit-breaker, circuit-breakers	→ 7/48
9 Clip plate	→ 7/69
Additional accessories	→ 7/56

Circuit diagrams	Contact sequence	Actuating voltage Voltage and frequency combination that can be implemented with a voltage trigger coil
------------------	------------------	------------------------------------------------------------------------------------------------------------

Shunt release (for power circuit-breakers)

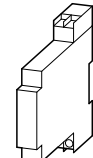
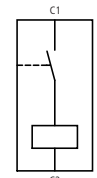
For AC and DC voltage

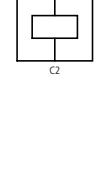
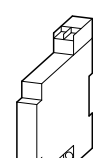
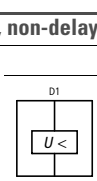
		24 V DC	48 V DC	60V DC
		24 V 50 Hz	48 V 50 Hz	
		24 V 60 Hz	48 V 60 Hz	
		110 V DC	125 V DC	250 V DC
		110 V 50 Hz	127 V 50 Hz	220 V 50 Hz
		230 V 50 Hz	240 V 50 Hz	
		110 V 60 Hz	120 V 60 Hz	208 V 60 Hz
		220 V 60 Hz	240 V 60 Hz	
		380 V 50 Hz	400 V 50 Hz	415 V 50 Hz
		440 V 50 Hz	500 V 50Hz	
		480 V 60 Hz	600 V 60 Hz	

Undervoltage releases, non-delayed

Without auxiliary contacts

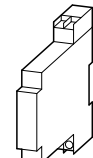
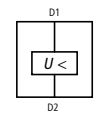
		For AC	-
		For DC	-

With auxiliary contact for AC

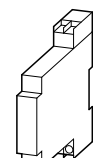
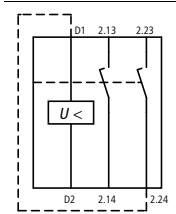
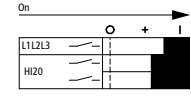
		On		-
		Off/Trip		

Undervoltage releases off-delayed, delay time 200 ms

With auxiliary contact for AC

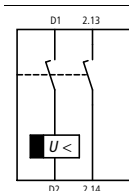
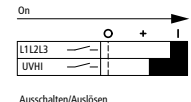
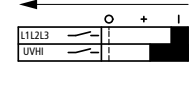

		On		-
		Ausschalten/Auslösen		



Information relevant for export to North America



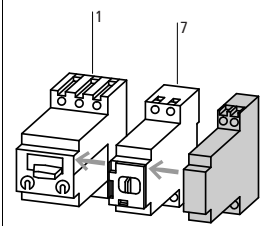

Product Standards	UL 508; CSA-C22.2 No. 14; IEC60947-4-1; CE marking
UL File No.	E29184
UL CEN	NKCR
CSA File No.	12528
CSA Class No.	3211-05
NA Certification	UL Listed, CSA certified

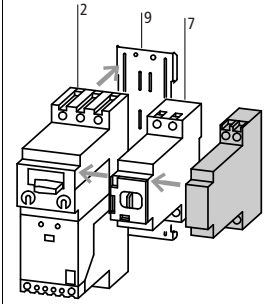
Part no. Article no.	Price See price list	Std. pack	Notes	Notes
-------------------------	-------------------------	-----------	-------	-------

A-PKZ2-A 063967		1 off 	Can be fitted to motor-protective circuit-breakers, circuit-breakers, and (high-capacity) compact starters	 <p>Accessories 1 Motor-protective circuit-breaker, circuit-breakers 7 Remote operators Additional accessories</p> <p>Page → 7/48 → 7/62 → 7/56</p>
A-PKZ2-B 063964		1 off 	Can be combined with remote operator.	
A-PKZ2-C 063930		1 off 		

U-PKZ2(230V50HZ,240V60HZ) 065766		1 off 	Can be fitted to motor-protective circuit-breakers, circuit-breakers, and (high-capacity) compact starters	 <p>Accessories 2 (High-capacity) compact starter 7 Remote operators 9 Clip plate Additional accessories Further actuating voltages</p> <p>Page → 7/51 → 7/62 → 7/69 → 7/56 → 7/70</p>
U-PKZ2(24VDC) 014463		1 off 	Can be combined with remote operator. When combined with circuit-breaker can be used as emergency switching off device to IEC/EN 60204.	

U-HI20-PKZ2(230V50HZ,240V60HZ) 065768		1 off 	Can be fitted to motor-protective circuit-breakers, circuit-breakers, and (high-capacity) compact starters Can be combined with remote operator. Two early-make N/O contacts built in. When combined with circuit-breaker, can be used as emergency switching off device to IEC/EN 60204. When the circuit-breaker is in the tripped position "+", the auxiliary contacts are closed. The undervoltage release can be energized early with an additional bridge (see circuit diagram). This function cannot be used in combination with RE/RS-PKZ2 (remote operator).	
-------------------------------------------------	--	------------------------------------------------------------------------------------------------	---------------------------------------------------------------------------------------------------------------------------------------------------------------------------------------------------------------------------------------------------------------------------------------------------------------------------------------------------------------------------------------------------------------------------------------------------------------------------------------------------------------------------------------------------------------------------------	--

UVHI-PKZ2(230V50HZ,240V60HZ) 065770		1 off 	Can be fitted to motor-protective circuit-breakers, circuit-breakers, and (high-capacity) compact starters Can be combined with remote operator. Two early-make N/O contacts built in. Voltage drops ≤ 200 ms do not cause opening; contact time 200 ms when switching on. When the circuit-breaker is in the tripped position "+", the auxiliary contacts are closed.	
-----------------------------------------------	--	------------------------------------------------------------------------------------------------	-------------------------------------------------------------------------------------------------------------------------------------------------------------------------------------------------------------------------------------------------------------------------------------------------------------------------------------------------------------------------------	--

Circuit diagrams

Circuit diagram for pulsed operation

OFF and RESET separate OFF equals RESET

RE-PKZ2 remote operator

Actuation through auxiliary contact

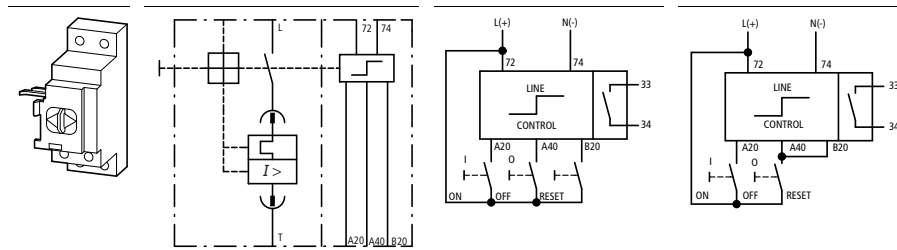

Power and control sections (line and control) have the same reference potential. Pulsed actuation ($\geq 2 \text{ VA/W}$, 15 ms) and two-wire control actuation are possible. Upon activation, the power section is supplied with power directly from the mains (700 VA/W, 30 ms). The control section can be actuated through NHI, AGM, ETS4-VS3, M22-(C)K... PLC with floating contacts without RC suppressor circuit.

Actuation through PLC semiconductor outputs

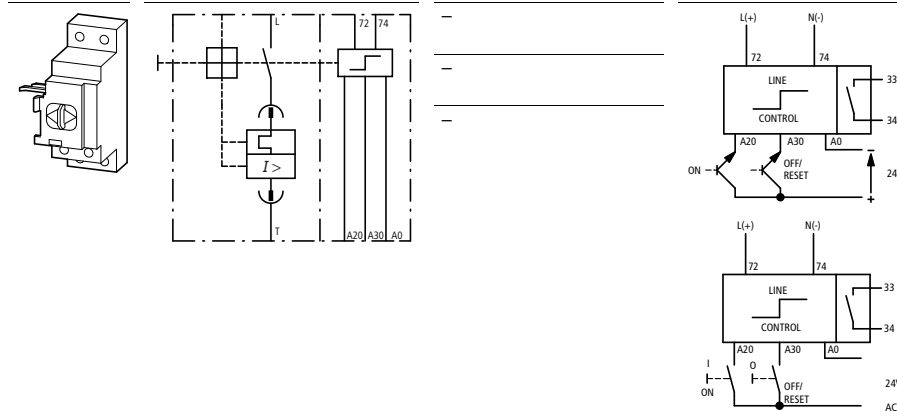

The power section and control section (line and control) are galvanically isolated from each other. Control section always 24 V. Safe isolation between the power section and control section is guaranteed. Pulsed ($\geq 2 \text{ VA/W}$, 15 ms) and two-wire control activation are possible. The control section can be actuated directly through PLC electronic outputs (24 VDC). When actuated, the power section is supplied with power directly from the mains (700VA/W, 30 ms).

Information relevant for export to North America



Product Standards	UL 508; CSA-C22.2 No. 14; IEC60947-4-1; CE marking
UL File No.	E29184
UL CCN	NKCR
CSA File No.	12528
CSA Class No.	3211-05
NA Certification	UL Listed, CSA certified

Part no. Article no.	Price See price list	Std. pack	Notes	Notes
RE-PKZ2(220-240V50/60HZ,DC) 063676		1 off		Can be fitted to circuit-breakers and (high-power) compact starters. Switches circuit-breakers ON/OFF remotely (or OFF after tripping). Remote operator can be switched off locally and the thumb-grip locked with a 6 mm padlock. Suitable for AC or DC voltage. Can be combined with voltage release U, U-HI20, UVHI-PKZ2 or A-PKZ2. Standard auxiliary contact NHI is always required for the combination of circuit-breaker and Remote operator RE/RS-PKZ2. Cannot be combined with door coupling handle PKZ2-X(R)H. . Mounting possible in switch position. Internal electronic interlock always prioritizes "OFF". Green slider position Δ "Manual" position (33/34) open. Red slider position Δ "Auto" position (33/34) closed. In "manual" position remote switching is not possible.
RE-PKZ2(110-120V50/60HZ,DC) 063673		1 off		
RE-PKZ2(24V50/60HZ,DC) 063670		1 off		
RS-PKZ2(220-240V50/60HZ,DC) 063688		1 off		Accessories 1 Motor-protective circuit-breaker, circuit-breakers → 7/48 3 Standard auxiliary contacts → 7/58 5 Trip-indicating auxiliary contact → 7/58 Additional accessories → 7/56
RS-PKZ2(380-415V50/60HZ) 063689		1 off		
RS-PKZ2(24V50/60HZ,DC) 063682		1 off		
 Accessories 2 (High-capacity) compact starter → 7/51 4 Standard auxiliary contacts → 7/58 5 Trip-indicating auxiliary contact → 7/58 9 Clip plate → 7/69				
Minimum command time: 				

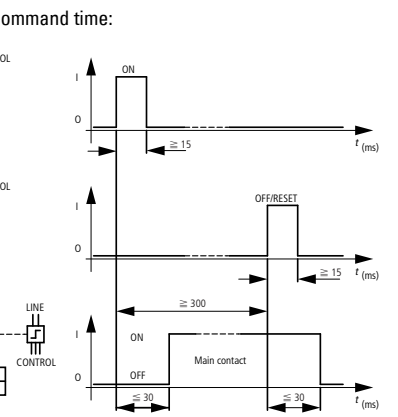

Circuit diagrams	Max. motor rating AC-3					Auxiliary contacts		For use with
	220 V	380 V	440 V	500 V	660 V	N/O = normally open contact	NC = normally closed contact	
	230 V	400 V			690 V			
	240 V	415 V						
	P	P	P	P	P			
	kW	kW	kW	kW	kW			

Contact modules

Part no. Article no.	Price	Std. pack	Notes
SE1A/11-PKZ2(230V50HZ,240V60HZ) 063711	See price list	1 off	Order clip plate for snap-fitting the combination separately. Can be fitted to 3 or 4 pole circuit-breaker. When combined with a clip plate, can be snap-fitted to one or two IEC/EN 60715 top-hat rails with 15 mm height.
SE1A/20-PKZ2(230V50HZ,240V60HZ) 063718	See price list	1 off	Can be mounted separately using base (see below), RC suppressor on request. DC version: The coil cannot be changed. Built-in auxiliary contact HI10-S-PKZ2 can be switched freely. The auxiliary contact cannot be changed. DC version with suppressor circuit (varistor suppressor).
SE1A-G-10-PKZ2(24VDC) 058856	See price list	1 off	High-capacity contact modules with serial no. 01 suitable for mounting with MV-PKZ2.

High-capacity contact module, with current limiting contacts¹⁾

Part no. Article no.	Price	Std. pack	Notes
S-PKZ2(230V50HZ,240V60HZ) 063696	See price list	1 off	Order clip plate for snap-fitting the combination separately. Can be fitted to 3 or 4 pole circuit-breaker. When combined with a clip plate, can be snap-fitted to one or two IEC/EN 60715 top-hat rails with 15 mm height.
S/HI20-S-PKZ2(230V50HZ,240V60HZ) 063703	See price list	1 off	Can be mounted separately using base (see below), RC suppressor on request. A coil change is not possible, the integrated HI10-S-PKZ2 auxiliary contact can be switched freely, an auxiliary contact change is not possible. With suppressor circuit (varistor suppressor).
S-G-PKZ2(24VDC) 070921	See price list	1 off	High-capacity contact modules with serial no. 01 suitable for mounting with MV-PKZ2.

Varistor suppressor

Part no. Article no.	Price	Std. pack	Notes
(E1A)-...-PKZ2	See price list	10 off	For (high-power) contact modules with AC actuation, 50 - 60 Hz
(E1A)-...-PKZ2	See price list	10 off	

Bases for separate mounting²⁾

Part no. Article no.	Price	Std. pack	Notes
(E1A)-...-PKZ2 CL-PKZ2	See price list	1 off	For retrofitting of (high-capacity) contact module or current limiter, separate mounting

Information relevant for export to North America



1) Product Standards UL 508; CSA-C22.2 No. 14; IEC60947-4-1; CE marking
 UL File No. E36332
 UL CCN NLRV
 CSA File No. 12528
 CSA Class No. 3211-05
 NA Certification UL Listed, CSA certified
 See also → Page 7/75

2) Product Standards UL 508; CSA-C22.2 No. 14; IEC60947-4-1; CE marking
 UL File No. E36332
 UL CCN NLRV
 CSA File No. 12528
 CSA Class No. 3211-05
 NA Certification UL Listed, CSA certified

Part no. Article no.	Price	Std. pack	Notes
SE1A/11-PKZ2(230V50HZ,240V60HZ) 063711	See price list	1 off	Order clip plate for snap-fitting the combination separately. Can be fitted to 3 or 4 pole circuit-breaker. When combined with a clip plate, can be snap-fitted to one or two IEC/EN 60715 top-hat rails with 15 mm height.
SE1A/20-PKZ2(230V50HZ,240V60HZ) 063718	See price list	1 off	Can be mounted separately using base (see below), RC suppressor on request. DC version: The coil cannot be changed. Built-in auxiliary contact HI10-S-PKZ2 can be switched freely. The auxiliary contact cannot be changed. DC version with suppressor circuit (varistor suppressor).
SE1A-G-10-PKZ2(24VDC) 058856	See price list	1 off	High-capacity contact modules with serial no. 01 suitable for mounting with MV-PKZ2.
S-PKZ2(230V50HZ,240V60HZ) 063696	See price list	1 off	Order clip plate for snap-fitting the combination separately. Can be fitted to 3 or 4 pole circuit-breaker. When combined with a clip plate, can be snap-fitted to one or two IEC/EN 60715 top-hat rails with 15 mm height.
S/HI20-S-PKZ2(230V50HZ,240V60HZ) 063703	See price list	1 off	Can be mounted separately using base (see below), RC suppressor on request. A coil change is not possible, the integrated HI10-S-PKZ2 auxiliary contact can be switched freely, an auxiliary contact change is not possible. With suppressor circuit (varistor suppressor).
S-G-PKZ2(24VDC) 070921	See price list	1 off	High-capacity contact modules with serial no. 01 suitable for mounting with MV-PKZ2.
VGSPKZ48 063974	See price list	10 off	For (high-power) contact modules with AC actuation, 50 - 60 Hz
VGSPKZ250 063973	See price list	10 off	
EZ-PKZ2 028596	See price list	1 off	For retrofitting of (high-capacity) contact module or current limiter, separate mounting

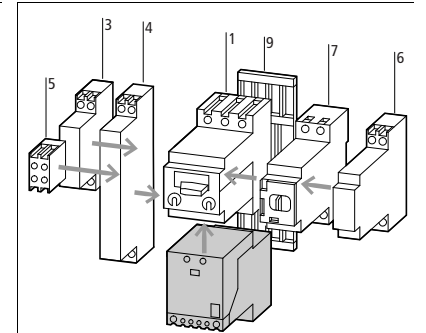

Accessories	Page
1 Motor-protective circuit-breaker, circuit-breakers	→ 7/48
3 Standard auxiliary contacts	→ 7/58
4 Standard auxiliary contacts	→ 7/58
5 Trip-indicating auxiliary contact	→ 7/58
6 Shunt releases, undervoltage releases	→ 7/60
7 Remote operators	→ 7/62
9 Clip plate	→ 7/69
Further actuation voltages	→ 7/71
Additional accessories	→ 7/56

When mounting separately, also functions as mounting base for auxiliary contact HI11-S/EZ-PKZ2.
 Can be snap-fitted on IEC/EN 60715 top-hat rail, or optional M4 screw fixing

For retrofitting of (high-capacity) contact module or current limiter, separate mounting

Contact configuration
N/O = normally open contact NC = normally closed contact

Contact sequence

Circuit diagrams

Control cable connection



Auxiliary contacts for (high-capacity) contact module, separate mounting

Can be fitted on side of base for separate mounting

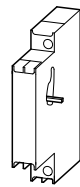

1 N/O

1 NC

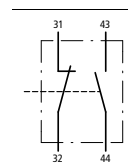
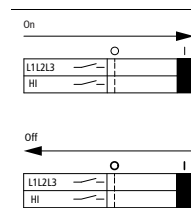

Auxiliary contacts for (high-capacity) contact module

Auxiliary contacts for exchange of integrated auxiliary contact in (high-capacity) contact module
Exchange not possible with contact module SE1A-G-10-PKZ2 or high-capacity contact module S-G-PKZ2



1 N/O

1 NC











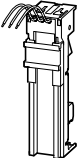

2 N/O

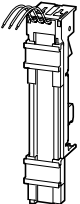
Mechanical interlock

For mechanically interlocking two separately mounted (high-capacity) contact modules or two (high-capacity) compact starters.
4 end brackets are included
Can be combined with high-capacity contact module S-PKZ2 with serial no. 01

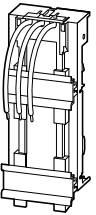

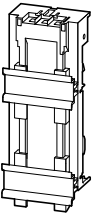
Part no. Article no.	Price See price list	Std. pack	Notes	Information relevant for export to North America
ST-PKZ2 010998		3 off 	1 set = 2 off VDE/IEC and UL/CSA compliant Connection option for fast-on connectors (insulated/non-insulated) 2.8 mm Max. cross-section 0.5 - 1 mm ² , 20 - 16 AWG Max. current tap off 1 A or 15 % of the set value Increase setting of thermal release accordingly. Enables control circuit supply to be tapped off between motor-protective circuit-breaker or circuit-breaker and (high-capacity) contact module.	Product Standards UL 508; CSA-C22.2 No. 14; IEC60947-4-1; CE marking
HI11-S/EZ-PKZ2 090305		1 off 		Product Standards UL 508; CSA-C22.2 No. 14; IEC60947-4-1; CE marking UL File No. E29184 UL CCN NKCR CSA File No. 12528 CSA Class No. 3211-05 NA Certification UL Listed, CSA certified
HI11-S-PKZ2 033936		1 off 	Accessories 8 High-capacity contact modules 10 Base for separate mounting Further actuating voltages	Page → 7/64 → 7/64 → 7/70
HI20-S-PKZ2 033935		1 off 		
MV-PKZ2 033938		1 off 		Product Standards UL 508; CSA-C22.2 No. 14; IEC60947-4-1; CE marking UL File No. E29184 UL CCN NKCR CSA File No. 12528 CSA Class No. 3211-05 NA Certification UL Listed, CSA certified

	Rated operating voltage U_e V	Cable cross-section	Adapter width mm	Mounting rails Number	For use with	Part no. Article no.	Price See price list	Std. pack	Notes
Busbar adapters for PKZ									
Approved to UL 508. For fitting to flat copper busbar with 60 mm between busbar centers, suitable for 5 mm and 10 mm busbar thickness.									
Rated operational current 63 A									
For motor-protective circuit breakers.									
	690	AWG 8 (10 mm ²)	72	1	PKZ2	BBA2-63¹⁾ 101458		4 Off  	-
	690	AWG 8 (10 mm ²)	54	1	PKZM4	BBA4-63¹⁾ 101457		4 Off  	-
For DOL starters.									
	690	AWG 8 (10 mm ²)	72	2	PKZ2 + DILM7 PKZ2 + DILM9 PKZ2 + DILM12 PKZ2 + DILM15 PKZ2 + DILM17 PKZ2 + DILM25 PKZ2 + DILM32 PKZ2 + DILM40	BBA2L-63¹⁾ 101480		2 Off  	-
	690	AWG 8 (10 mm ²)	55	2	PKZM4 + DILM17 PKZM4 + DILM25 PKZM4 + DILM32 PKZM4 + DILM40 PKZM4 + DILM50 PKZM4 + DILM65	BBA4L-63¹⁾ 101459		4 Off  	The following can be used for an electrical connection: PKZM4 + DILM40 bis DILM65: PKZM4-XM65DE usable.
	690	AWG 8 (10 mm ²)	72	2	PKZ2 + DILM7 PKZ2 + DILM9 PKZ2 + DILM12 PKZ2 + DILM15 PKZ2 + DILM17 PKZ2 + DILM25 PKZ2 + DILM32 PKZ2 + DILM38 PKZ2 + DILM40 PKZ2 + DILM50 PKZ2 + DILM65 SE1A/...-PKZ2 + C-PKZ2 S-PKZ2 + C-PKZ2	BBA2-63/2TS²⁾ 116900		4 Off  	For DOL starters.
Rated operational current 80 A									
Can be used universally.									
	690	-	72	2	PKZ2 + DILM7 PKZ2 + DILM9 PKZ2 + DILM12 PKZ2 + DILM15 PKZ2 + DILM17 PKZ2 + DILM25 PKZ2 + DILM32 PKZ2 + DILM38 PKZ2 + DILM40 PKZ2 + DILM50 PKZ2 + DILM65	BBA2-80/2TS-S²⁾ 116901		4 Off  	Universal adapter for 1, 2 and 3-phase applications, not suitable without additional UL/CSA component. For conductor cross-section, round conductors up to 16 mm ² or AWG6.











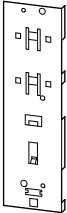

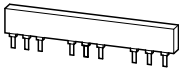

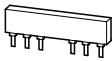

Notes

Information relevant for export to North America

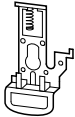

1)	Product Standards	UL 508A; CSA-C22.2 No. 14; IEC60439-1; CE marking
	UL File No.	E300273
	UL CCN	NMTR
	CSA File No.	232140
	CSA Class No.	3211-37
	NA Certification	UL Recognized, CSA certified
	Max. Voltage Rating	600 V AC

2)	Product Standards	UL 508A; CSA-C22.2 No. 14; IEC60439-1; CE marking
	UL File No.	E300273
	UL CCN	NMTR
	NA Certification	UL Recognized, CSA certified
	Max. Voltage Rating	600 V AC

For use with	Part no. Article no.	Price See price list	Std. pack	Notes
Clip plate				
For optional snap-on and M4 screw fixing for circuit-breakers with (high-power) contact module or current limiter				
	Can be used with busbar adapter	C-PKZ2 052710	2 Off  	Can be snap-fitted to one IEC/EN 60715 top-hat rails with 15 mm height or two top-hat rails exceeding 10 mm height UL/CSA certification not required
Three-phase commoning links				
	For wiring 3 PKZ2s, space is provided for either 2 auxiliary contacts or 2 voltage releases	B3.1/3-PKZ2¹⁾ 033940	5 Off  	Can be extended to several PKZ2s by rotated mounting, protected against accidental contact $U_e = 690 \text{ V}$, $I_u = 120 \text{ A}$, short-circuit proof
	For wiring of 2 PKZ2, space is provided for either 1 auxiliary contact or 1 shunt release	B3.1/2-PKZ2¹⁾ 063969	5 Off  	
Supply terminal				
For three-phase commoning link, protected against accidental contact $U_e = 690 \text{ V}$, $I_u = 120 \text{ A}$				
	–	BK50/3-PKZ2²⁾ 033941	2 Off  	For connection of: max. $1 \times 50 \text{ mm}^2$ or $2 \times 35 \text{ mm}^2$ above one another; min. $1 \times 1 \text{ mm}^2$ or $2 \times 1 \text{ mm}^2$
Shroud for unused terminals				
Protection against direct contact. To cover unused terminals on three-phase commoning link				
	–	H-B3-PKZ2 063968	10 Off	Snap-fitting option must be available on the three-phase commoning link
Padlocking feature				
For locking the circuit-breaker in the 0 position when the control panel door is open (rear-mounting type)				
	–	SVB-PKZ2¹⁾ 050337	5 Off  	Suitable for 3 padlocks with 5 – 8 mm hasp thickness
Coding pins				
For coding (in dual coding system) the devices assigned from trip block to PKZ2(4) basic device				
	–	CS-PKZ2³⁾ 055083	1 Off  	–
Documentation				
PKZM2 motor-protective circuit breakers, overload monitoring of EEx e motors				
German/English		AWB1210-1485D/GB 266166	1 Off	–

Information relevant for export to North America



1) Product Standards UL File No. UL CCN CSA File No. CSA Class No. NA Certification	UL 508; CSA-C22.2 No. 14; IEC60947-4-1; CE marking E36332 NLRV 12528 3211-05 UL Listed, CSA certified	2) Product Standards UL File No. UL CCN CSA File No. CSA Class No. NA Certification	UL 508; CSA-C22.2 No. 14; IEC60947-4-1; CE marking E36332 NLRV 98494 3211-06 UL Listed, CSA certified	3) Product Standards UL File No. UL CCN CSA File No. NA Certification	UL 508; CSA-C22.2 No. 14; IEC60947-4-1; CE marking E36332 NLRV On request UL Listed, CSA certified
-------------------------------------------------------------------------------------------------------	----------------------------------------------------------------------------------------------------------------------	-------------------------------------------------------------------------------------------------------	----------------------------------------------------------------------------------------------------------------------	--------------------------------------------------------------------------------------	----------------------------------------------------------------------------------------------------------------

Compact starters

Contact module with 1 normally open and 1 normally closed auxiliary contact

AC	PKZ2/ZM-1/SE1A/ 11(...)	PKZ2/ZM-1.6/SE1A/ 11(...)	PKZ2/ZM-2.4/SE1A/ 11(...)	PKZ2/ZM-4/SE1A/ 11(...)	PKZ2/ZM-6/SE1A/ 11(...)
	Article no. ¹⁾	Article no. ¹⁾	Article no. ¹⁾	Article no. ¹⁾	Article no. ¹⁾
Standard voltage	See price list	See price list	See price list	See price list	See price list
230 V 50 Hz, 240 V 60 Hz	063364	063372	063382	063392	063402
110 V 50/60 Hz	–	–	–	–	063408
230 V 50/60 Hz	063369	063379	063389	063399	063409

Compact starters

Contact module with 1 normally open and 1 normally closed auxiliary contact

AC	PKZ2/ZM-10/ SE1A/11(...)	PKZ2/ZM-16/ SE1A/11(...)	PKZ2/ZM-25/ SE1A/11(...)	PKZ2/ZM-32/ SE1A/11(...)	PKZ2/ZM-40/ SE1A/11(...)	PKZ2/ SE1A/11(...)
	Article no. ¹⁾	Article no. ¹⁾	Article no. ¹⁾	Article no. ¹⁾	Article no. ¹⁾	Article no. ¹⁾
Standard voltage	See price list	See price list	See price list	See price list	See price list	See price list
230 V 50 Hz, 240 V 60 Hz	063412	063422	063432	063442	063452	082142
110 V 50/60 Hz	063418	063428	063438	063448	063458	–
230 V 50/60 Hz	063419	063429	063439	063449	063459	082148

High-capacity compact starters

Contact module with 1 normally open and 1 normally closed auxiliary contact

AC	PKZ2/ZM-1/S(...)	PKZ2/ZM-1.6/S(...)	PKZ2/ZM-2.4/S(...)	PKZ2/ZM-4/S(...)	PKZ2/ZM-6/S(...)
	Article no. ¹⁾	Article no. ¹⁾	Article no. ¹⁾	Article no. ¹⁾	Article no. ¹⁾
Standard voltage	See price list	See price list	See price list	See price list	See price list
230 V 50 Hz, 240 V 60 Hz	063472	063482	063492	063502	063512
110 V 50/60 Hz	063478	063488	063498	063508	063518
230 V 50/60 Hz	063479	063489	063499	063509	063519

High-capacity compact starters

Contact module with 1 normally open and 1 normally closed auxiliary contact

AC	PKZ2/ZM-10/ S(...)	PKZ2/ZM-16/ S(...)	PKZ2/ZM-25/ S(...)	PKZ2/ZM-32/ S(...)	PKZ2/ZM-40/ S(...)	PKZ2/S(...)
	Article no. ¹⁾	Article no. ¹⁾	Article no. ¹⁾	Article no. ¹⁾	Article no. ¹⁾	Article no. ¹⁾
Standard voltage	See price list	See price list	See price list	See price list	See price list	See price list
110 V 50 Hz, 120 V 60 Hz	–	–	–	–	–	063570
230 V 50 Hz, 240 V 60 Hz	063522	063532	063542	063552	063562	063572
24 V 50/60 Hz	–	–	–	–	–	063577
110 V 50/60 Hz	063528	063538	063548	063558	063568	–
230 V 50/60 Hz	063529	063539	063549	063559	063569	063579

Notes

¹⁾ To obtain the complete part number, append the actuating voltage (...) to the part nos. given above.
Devices with **dual-voltage coils** must be ordered with a **single article no.**

Undervoltage release	When ordered separately		
	U-PKZ2(...)	U-HI20-PKZ2(...)	UVHI-PKZ2(...)
AC	Article no. ¹⁾	Article no. ¹⁾	Article no. ¹⁾
Standard voltage	See price list	See price list	See price list
24 V 50 Hz	055085	-	-
110 V 50 Hz, 120 V 60 Hz	-	063655	-
220 V 50 Hz, 240 V 60 Hz	065685	063656	-
230 V 50 Hz, 240 V 60 Hz	065766	065768	065770
400 V 50 Hz, 440 V 60 Hz	065767	-	-
24 V 50/60 Hz	-	063659	-
Non-standard voltages with the exception of the shown standard voltages ²⁾ .	-	See price list	-
...V 50Hz (24 – 600 V)	-	907537 ³⁾	-
...V 60Hz (24 – 600 V)	-	907538 ³⁾	-
DC			
Standard voltage	See price list	-	-
24V DC	014463	-	-
48V DC	028701	-	-

Notes

¹⁾ To obtain the complete part number, append the actuating voltage (...) to the part nos. given above.

Devices with **dual-voltage coils** must be ordered with a **single** article no.

²⁾ For non-standard voltages, specify the required actuating voltage within the indicated range (... - ... V).

³⁾ Minimum order quantity: 10 units.

(High-capacity) contact modules

AC	S-PKZ2(...)	S/Hi20-S-PKZ2(...)	SE1A/11-PKZ2(...)	SE1A/20-PKZ2(...)
	Article no. ¹⁾	Article no. ¹⁾	Article no. ¹⁾	Article no. ¹⁾
Standard voltage	See price list	See price list	See price list	See price list
24 V 50 Hz	026609	-	-	-
48 V 50 Hz	062651	056383	-	-
240 V 50 Hz	001882	057048	058716	058717
24 V 60 Hz	062501	-	-	-
110 V 50 Hz, 120 V 60 Hz	063694	063701	063709	063716
190 V 50 Hz, 220 V 60 Hz	063695	-	063710	063717
220 V 50 Hz, 240 V 60 Hz	063699	063706	-	-
230 V 50 Hz, 240 V 60 Hz	063696	063703	063711	063718
400 V 50 Hz, 440 V 60 Hz	063697	-	063712	063719
24 V 50/60 Hz	062500	-	058720	058721
110 V 50/60 Hz	-	-	058696	-
230 V 50/60 Hz	065103	056395	058712	058713
DC	S-G-PKZ2(...)	SE1A-G-10-PKZ2(...)		
	Article no. ¹⁾	Article no. ¹⁾		
Standard voltage	See price list	See price list		
24 V DC	070921	058856		

Notes

¹⁾ To obtain the complete part number, append the actuating voltage (...) to the part nos. given above.

Devices with **dual-voltage coils** must be ordered with a **single** article no.



Tripping characteristic curves, motor-protective circuit-breakers, (high-power) compact starters

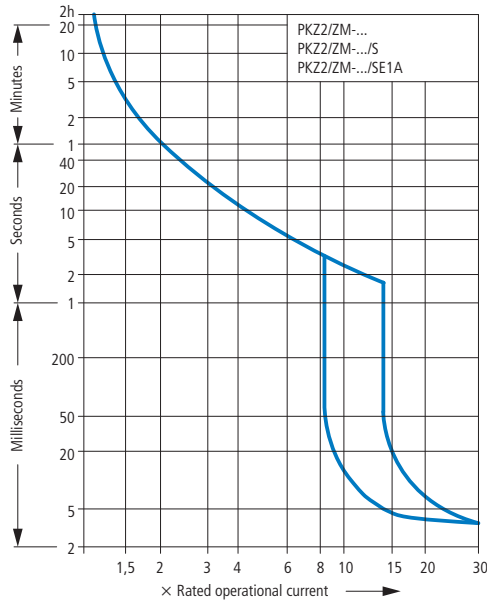

Tripping characteristic curves, line protection

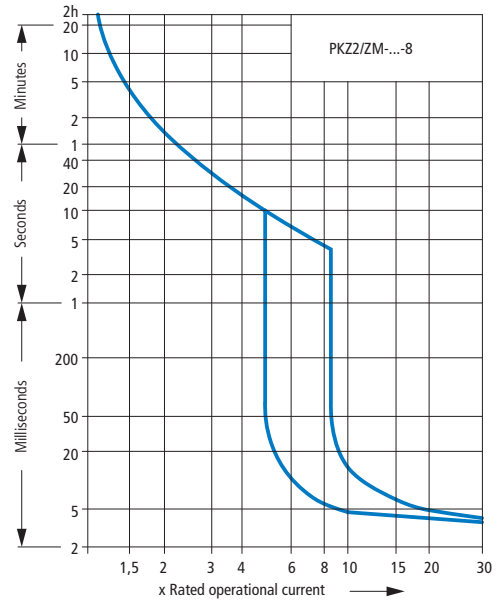

Let-through characteristics, circuit-breakers, compact starters

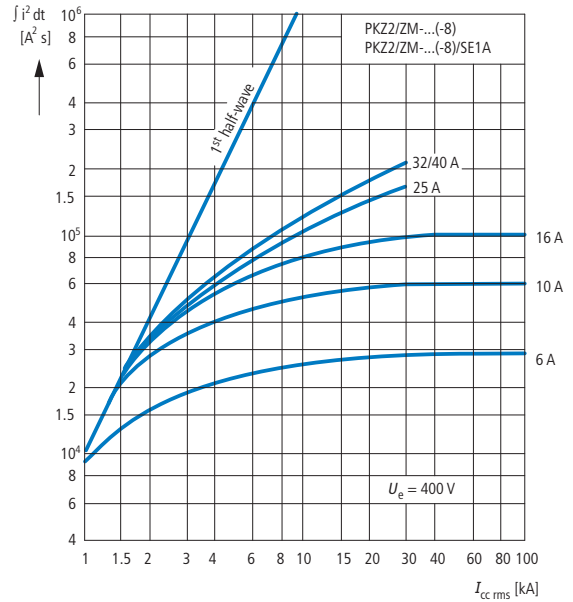
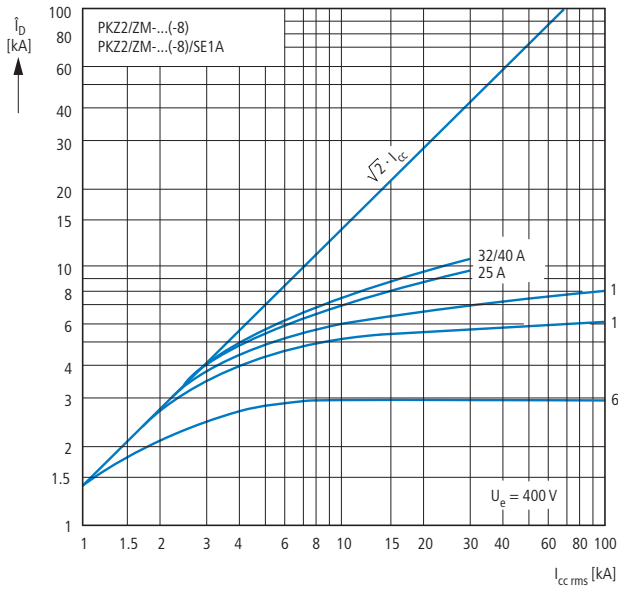

Let-through characteristics, high-capacity compact starters and circuit-breakers + current limiters CL

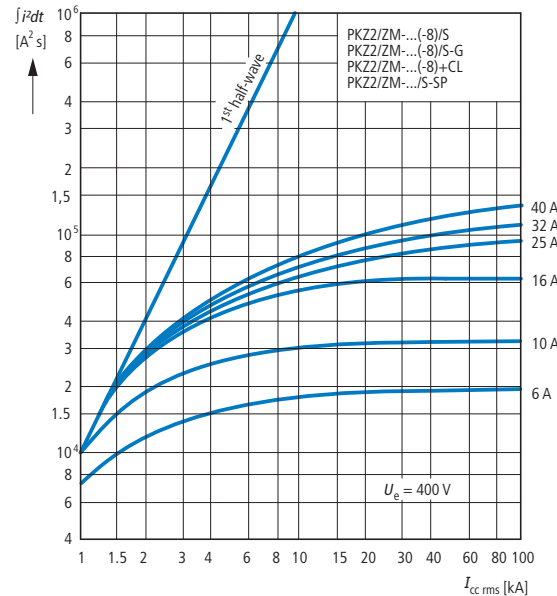
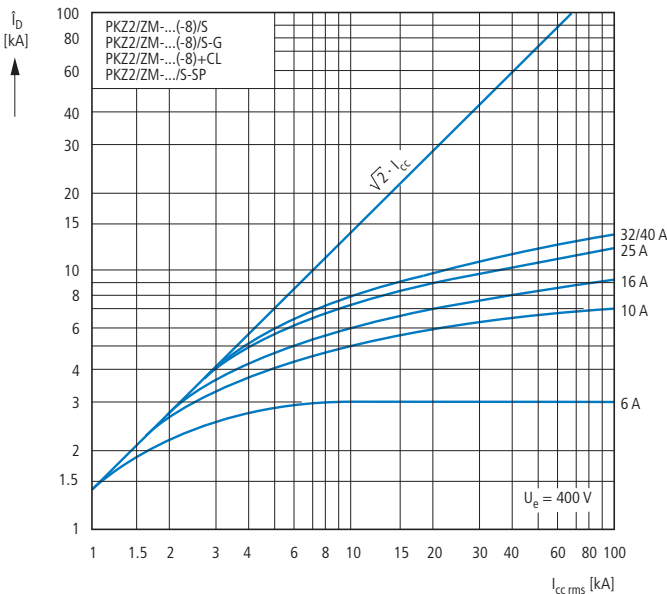

High-capacity contact module S-PKZ2, contact module SE1A-PKZ2

Normal switching duty

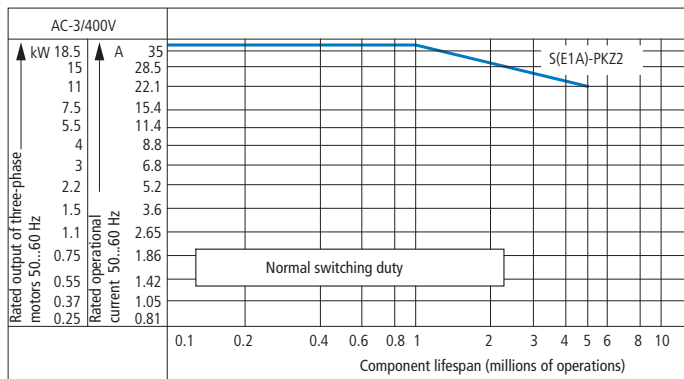

Squirrel-cage motor

Operating characteristics: Switch on: From standstill
Switch off: While running

Typical applications: Compressors, Lifts, Mixers, Pumps, Escalators, Agitators, Fans, Conveyor belts, Centrifuges, Hinged flaps, Bucket-elevator, Air-conditioning system

General drives for manufacturing and processing machines

Electrical Characteristic: Switch on: Up to 6 x motor rated current
Switch off: 1 x motor rated current

Utilization category: 100 % AC-3

Extreme switching duty

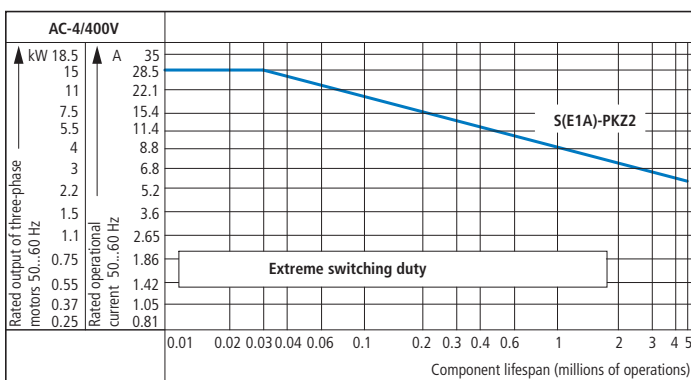

Squirrel-cage motor

Operating characteristics: Inching, DC braking, reversing

Typical applications: Printing machines, Wire-drawing machines, Centrifuges, Special drives for machining centers and machine tools

Electrical Characteristic: Switch on: 6 x motor rated current
Switch off: 6 x motor rated current

Utilization category: 100 % AC-4

Light switching duty

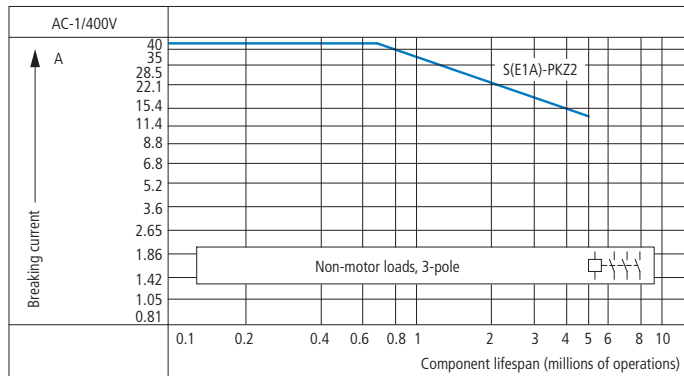

Non-motor loads

Operating characteristics: Non inductive and slightly inductive loads

Typical applications: Electric heat

Electrical Characteristic: Switch on: Up to 1.5 x rated operational current
Switch off: Up to 1.5 x rated operational current

Utilization category: 100 % AC-1

Determination of the maximum operating frequency dependant on the rating and utilization category (recommended values) for (high capacity) contact modules

PN = max. motor rated output (kW)
Ops/h = max. operations per hour

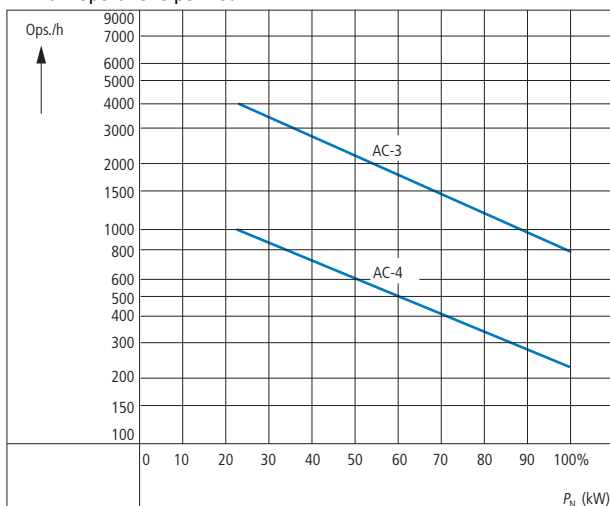

Motor-protective circuit-breakerswitching capacity and (high-capacity) compact starter

Rated uninterrupted current I_u

Rated conditional short-circuit current I_q IEC/EN 60947-4-1

Rated ultimate short-circuit breaking capacity I_{cu}
 Rated breaking capacity I_{cs} } IEC/EN 60947-2

I_u A	230 V				400 V				440 V				500 V				690 V			
	I_q kA	I_{cu} kA	I_{cs} kA	A ¹⁾	I_q kA	I_{cu} kA	I_{cs} kA	A ¹⁾	I_q kA	I_{cu} kA	I_{cs} kA	A ¹⁾	I_q kA	I_{cu} kA	I_{cs} kA	A ¹⁾	I_q kA	I_{cu} kA	I_{cs} kA	A ¹⁾
0.16 – 1.6				N				N				N				N				N
2.4				N				N				N				N				N
4				N				N				N				N				N
6				N				N				N				N	4.5	4.5	2.5	63
10			30	N			30	N	10	10	5	80	7	7	3.5	80	4.5	4.5	2.5	80
16			30	N			30	N	10	10	5	100	7	7	3.5	100	4.5	4.5	2.5	100
25	30	30	7.5	160	30	30	7.5	160	10	10	5	125	7	7	3.5	125	4.5	4.5	2.5	125
32	30	30	7.5	160	30	30	7.5	160	10	10	5	160	7	7	3.5	160	4.5	4.5	2.5	160
40	30	30	7.5	160	30	30	7.5	160	10	10	5	160	7	7	3.5	160	4.5	4.5	2.5	160

PKZ2/ZM + CL-PKZ2 type "1" and "2" coordination

0.16 – 1.6				N				N				N				N				N
2.4				N				N				N				N				N
4				N				N				N				N	10	4.5	2.5	N
6				N				N				N				N	10	4.5	2.5	N
10			30	N			30	N			5	N			3.5	N	10	4.5	2.5	N
16			30	N			30	N			5	N			3.5	N	10	4.5	2.5	N
25			7.5	N			7.5	N			5	N			3.5	N	10	4.5	2.5	N
32			7.5	N			7.5	N			5	N			3.5	N	10	4.5	2.5	N
40			7.5	N			7.5	N			5	N			3.5	N	10	4.5	2.5	N

PKZ2/ZM(R).../SE1A(-G)... with type "1" of coordination

0.16 – 1.6				N				N				N				N				N
2.4				N				N				N				N				N
4				N				N				N				N	4.5	N	N	63
6				N				N				N				N	4.5	N	N	80
10				N				N	10	N	N	80	7	N	N	80	4.5	N	N	80
16				N				N	10	N	N	100	7	N	N	100	4.5	N	N	100
25	30	N	N	160	30	N	N	160	10	N	N	125	7	N	N	125	4.5	N	N	125
32	30	N	N	160	30	N	N	160	10	N	N	160	7	N	N	160	4.5	N	N	160
40	30	N	N	160	30	N	N	160	10	N	N	160	7	N	N	160	4.5	N	N	160

PKZ2/ZM.../S(-G) with type "1" and "2" coordination

0.6 – 2.4				N				N				N				N				N
4 – 6				N				N				N				N				N
10 – 16				N				N				N				N	10	N	N	80
25 – 40				N				N				N				N	10	N	N	100

PKZ2/ZM...-8 and PKZ2/ZM...-8/SE1A(-G)

0.16 – 1.6	N			N	N			N	N			N	N			N	N			N
2.4	N			N	N			N	N			N	N			N	N			N
4	N			N	N			N	N			N	N			N	N	4.5	2.5	63
6	N			N	N			N	N			N	N			N	N	4.5	2.5	80
10	N		30	N	N		30	N	N	10	5	80	N	7	3.5	80	N	4.5	2.5	80
16	N		30	N	N		30	N	N	10	5	100	N	7	3.5	100	N	4.5	2.5	100
25	N	30	7.5	160	N	30	7.5	160	N	10	5	125	N	7	3.5	125	N	4.5	2.5	125
32	N	30	7.5	160	N	30	7.5	160	N	10	5	160	N	7	3.5	160	N	4.5	2.5	160
40	N	30	7.5	160	N	30	7.5	160	N	10	5	160	N	7	3.5	160	N	4.5	2.5	160

PKZ2/ZM...-8/S(-G)

0.6 – 2.4	N			N	N			N	N			N	N			N	N			N
4 – 6	N			N	N			N	N			N	N			N	N	10	5	80
10 – 16	N			N	N			N	N			N	N			N	N	10	5	100
25 – 40	N			N	N			N	N			N	N			N	N	10	5	160

Notes

■ No upstream protective device required, as it is the auto-protected range (100 kA)

N Not necessary

¹⁾ Fuse (A gG/gL) for increasing the switching capacity of the motor-protective circuit-breaker to 100 kA

Approvals for world markets

Approved rating data ¹⁾ UL 508/CSA C 22.2 No. 14	Maximum motor rating				Setting ranges		Maximum protective device to UL/CSA			
	Three-phase current				Overload releases	Short-circuit-releases	Group protection ¹⁾			
	200 V HP	230 V HP	460 V HP	575 V HP			Up to max. short-circuit rating 480 V kA	600 V kA	Maximum fuse rating A	Maximum circuit breaker A
Motor-protective circuit-breakers PKZ2	"Manual Motor Starter with thermal and magnetic trip"									
PKZ2/ZM-0.6	2)				0.4 – 0.6	5 – 8	65	42	500	600
PKZ2/ZM-1			½	½	0.6 – 1	8 – 14	65	42	500	600
PKZ2/ZM-1.6			¾	1	1 – 1.6	14 – 22	65	42	500	600
PKZ2/ZM-2.4	½	½	1	1½	1.6 – 2.4	20 – 35	65	42	500	600
PKZ2/ZM-4	1	1	2	3	2.4 – 4	35 – 55	65	42	500	600
PKZ2/ZM-6	1½	1½	3	5	4 – 6	50 – 80	65	42	500	600
PKZ2/ZM-10	2	3	5	7½	6 – 10	80 – 140	65	42	500	600
PKZ2/ZM-16	3	5	10	10	10 – 16	130 – 220	65	42	500	600
PKZ2/ZM-25	7½	7½	20	25	16 – 27	200 – 350	65	42	500	600
PKZ2/ZM-32	10	10	20	30	24 – 32	275 – 425	65	42	500	600
PKZ2/ZM-40	10	15	30	30	32 – 42	350 – 500	65	42	500	600
High-power compact starters PKZ2	"Manual Motor Starter with thermal, magnetic trip and contactor"									
PKZ2/ZM-0.6/S(...)	2)				0.4 – 0.6	5 – 8	65	42	2000	2000
PKZ2/ZM-1/S(...)			½	½	0.6 – 1	8 – 14	65	42	2000	2000
PKZ2/ZM-1.6/S(...)			¾	1	1 – 1.6	14 – 22	65	42	2000	2000
PKZ2/ZM-2.4/S(...)	½	½	1	1½	1.6 – 2.4	20 – 35	65	42	2000	2000
PKZ2/ZM-4/S(...)	1	1	2	3	2.4 – 4	35 – 55	65	42	2000	2000
PKZ2/ZM-6/S(...)	1½	1½	3	5	4 – 6	50 – 80	65	42	2000	2000
PKZ2/ZM-10/S(...)	2	3	5	7½	6 – 10	80 – 140	65	42	2000	2000
PKZ2/ZM-16/S(...)	3	5	10	10	10 – 16	130 – 220	65	42	2000	2000
PKZ2/ZM-25/S(...)	7½	7½	20	25	16 – 27	200 – 350	65	42	2000	2000
PKZ2/ZM-32/S(...)	10	10	20	30	24 – 32	275 – 425	65	42	2000	2000
PKZ2/ZM-40/S(...)	10	15	30	30	32 – 42	350 – 500	65	42	2000	2000
High-capacity contact modules	"Contact module" in combination with PKZ2/ZM(R)-... motor-protective circuit-breaker or base for separate mounting of EZ-PKZ2									
S-PKZ2(...)	10	15			30	30				
S/HI20-S-PKZ2(...)	10	15			30	30				
S-G-PKZ2(...)	10	15			30	30				
Reversing combination	"Reversing combination" in combination with trip block ZM-...PKZ2 for motor protection									
PKZ2/SW-MV-11(...)	10	15			30	30				
Reversing busbar sys-	42 A 600 V AC									
A BK50/3-PKZ2 terminal must be ordered separately for UL/CSA use.										

¹⁾ Caution: Changed requirements for group protection

²⁾ Calculate motor power in this range according to the rated operational current.



Approved rating data ¹⁾ UL 508/CSA C 22.2 No. 14	Maximum motor rating				Setting ranges	
	Three-phase current				Overload releases	Short-circuit-releases
	200 V	230 V	460 V	575 V	A	A
	208 V	240 V	480 V	600 V		
	HP	HP	HP	HP		
Basic device	"Basic device" In connection with motor protection trip block ZM-...-PKZ2 ZMR-...-PKZ2					
PKZ2	10	15	30	30		
Motor protection trip module with overload relay function	"Motor Protection Trip Module with overload relay function"					
ZMR-0.6-PKZ2	2)				0.4 – 0.6	5 – 8
ZMR-1-PKZ2					0.6 – 1	8 – 14
ZMR-1.6-PKZ2					1 – 1.6	14 – 22
ZMR-2.4-PKZ2	½	½	1	1½	1.6 – 2.4	20 – 35
ZMR-4-PKZ2	1	1	2	3	2.4 – 4	35 – 55
ZMR-6-PKZ2	1½	1½	3	5	4 – 6	50 – 80
ZMR-10-PKZ2	2	3	5	7½	6 – 10	80 – 140
ZMR-16-PKZ2	3	5	10	10	10 – 16	130 – 220
ZMR-25-PKZ2	7½	7½	20	25	16 – 27	200 – 350
ZMR-32-PKZ2	10	10	20	30	24 – 32	275 – 425
ZMR-40-PKZ2	10	15	30	30	32 – 42	350 – 500
Auxiliary contact ZMB	Pilot Duty General Purpose Terminal capacity Torque				D 300, R 300 1.5 A 240 V AC 0.6 A 600 V AC AWG 18 ... 14 1 Nm/9 lb.-in	
Motor protection Trip module						
ZM-1.6-PKZ2	2)				0.4 – 0.6	5 – 8
ZM-1-PKZ2					0.6 – 1	8 – 14
ZM-1.6-PKZ2					1 – 1.6	14 – 22
ZM-2.4-PKZ2	½	½	1	1½	1.6 – 2.4	20 – 35
ZM-4-PKZ2	1	1	2	3	2.4 – 4	35 – 55
ZM-6-PKZ2	1½	1	3	5	4 – 6	50 – 80
ZM-10-PKZ2	2	3	5	7½	6 – 10	80 – 140
ZM-16-PKZ2	3	5	10	10	10 – 16	130 – 220
ZM-25-PKZ2	7½	7½	20	25	16 – 27	200 – 350
ZM-32-PKZ2	10	10	20	30	24 – 32	275 – 425
ZM-40-PKZ2	10	15	30	30	32 – 42	350 – 500
Notes	Service factor (SF)	Set value I_r on the current scale depending on the load factor			1) Devices for world markets IEC q UL/CSA.	
		SF = 1.15 → $I_r = 1 \times I_{n\text{ mot}}$ SF = 1 → $I_r = 0.9 \times I_{n\text{ mot}}$			2) Calculate motor power in this range according to the rated operational current. Stated values to NEC Table 430 – 150.	
	Terminal capacity	High-capacity compact starters PKZ2/ZM-.../S, Motor-protective circuit-breaker PKZ2/ZM-... Cables Cu 75 °C, min. AWG 14, max. AWG 6 Torque 1.8 Nm				

Approved rating data ¹⁾			Pilot Duty	General Use	
Ordering data, motor-protective circuit-breaker PKZ2/S-SP "Self-Protected Starter" → Page 7/53				AC	DC
Accessories					
Standard auxiliary contacts	NHI11-PKZ2	PKZ2/ZM..., PKZ2...SP	A 600, R 300	5 A – 600 V	0.5 A – 250 V
	NHI22-PKZ2	PKZ2/ZM..., PKZ2...SP		10 A – 300 V	
	NHI11S-PKZ2	PKZ2/ZM-...			
	NHI22S-PKZ2	PKZ2/ZM-...			
	NHI2-11S-PKZ2	PKZ2/ZM-...			
Trip-indicating auxiliary contacts	AGM2-11-PKZ2	PKZ2/ZM..., PKZ2...SP	A 600, R 300	10 A – 600 V	0.5 A – 250 V ²⁾
Short-circuit indicators	K-AGM-PKZ2	PKZ2/ZM..., PKZ2...SP			
Shunt release	A-PKZ2-...	PKZ2/ZM..., PKZ2...SP	B 600, R 300	24 – 600 V	24 – 250 V
	U-PKZ2(...)	PKZ2/ZM..., PKZ2...SP		24 – 600 V	24 – 125 V
	U-HI20-PKZ2(...)	PKZ2/ZM..., PKZ2...SP		24 – 600 V	24 – 125 V
	UVHI-PKZ2(...)	PKZ2/ZM..., PKZ2...SP		24 – 600 V	24 – 125 V
Auxiliary contacts for contact module	HI11-S-PKZ2	PKZ2/ZM-...	A 600, R 300	10 A – 600 V	0.5 A – 250 V ²⁾
	HI20-S-PKZ2	PKZ2/ZM-...	A 600	10 A – 600 V	
	HI11-S/EZ-PKZ2	PKZ2/ZM-...	A 600, R 300	5 A – 600 V 10 A – 300 V	0.5 A – 250 V ²⁾
Remote operator	RE-PKZ2	PKZ2/ZM..., PKZ2...SP	³⁾		
	RS-PKZ2	PKZ2/ZM..., PKZ2...SP	D 300 – R 300	1.5 A – 240 V AC 0.6 A – 600 V AC	
Amplifier module for remote drives	ETS4-VS3	PKZ2/ZM..., PKZ2...SP	B 300 – R 300	5 A – 250 V AC	
Clip plates	C-PKZ2	PKZ2/ZM-...			
Door coupling handles	H-PKZ2	PKZ2/ZM..., PKZ2...SP			
	RH-PKZ2	PKZ2/ZM..., PKZ2...SP			
Extension shaft	A-H-PKZ2	PKZ2/ZM..., PKZ2...SP			
Base for separate mounting	EZ-PKZ2	–			
Three-phase commoning links	B3.1/3-PKZ2	PKZ2/ZM..., PKZ2...SP	max. 100 A		
	B3.1/2-PKZ2	PKZ2/ZM..., PKZ2...SP	max. 85 A		
Connecting Terminals for three-phase commoning links	BK50/3-PKZ2	PKZ2/ZM..., PKZ2...SP	max. 100 A Terminal capacity Torque	AWG 14-0 4.5 Nm	
Padlocking feature	SVB-PKZ2	PKZ2/ZM..., PKZ2...SP			
Mechanical interlock	MV-PKZ2	–			
Coding pins	CS-PKZ2	PKZ2/ZM..., PKZ2...SP			
Busbar adapters	AD-...	PKZ2/ZM..., PKZ2...SP			

Notes

Terminal capacities for all PKZ2 system add-on modules:

- Cables min. AWG 18, max. AWG 14
- Torque 1.0 Nm

¹⁾ Device for world markets IEC = UL/CSA.

²⁾ >150 V same polarity.

³⁾ Maximum actuating voltage 120 V 60 Hz or 120 V DC.

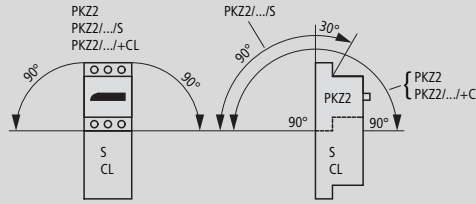

Technical data

				PKZ2/ZM-...(8)	PKZ2/ZM-... (8)/SE...	PKZ2/ZM-...(8)/S(+CL)	S(EA)...
General							
Standards				IEC/EN 60947, VDE 0660, UL 508, CSA C 22.2 No. 14, GL, LR, DNV, PRS, BV, RINA, RS, EZU, MEEI			
Climatic proofing				Damp heat, constant, to IEC 60068-2-78; cyclic to IEC 60068-2-30			
Ambient temperature	Storage	°C	-25...70	-25...70	-25...70	-25...70	
	Open	°C	-25...60	-25...60	-25...60	-25...60	
	Encapsulated	°C	-25...40	-25...40	-25...40	-25...40	
Built-in position							
Direction of incoming supply				Any	Any	Any	Any
Degree of protection				IP00	IP00	IP00	IP00
Mechanical shock resistance							
Half-sinusoidal shock 20 ms to IEC 60068-2-27			g	30	8	8	8
Installation altitude				m	max. 2000	max. 2000	max. 2000
Terminal capacity	Solid or stranded	mm ²	1 x (1 - 16) 2 x (1 - 6)	1 x (1 - 16) 2 x (1 - 6)	1 x (1 - 16) 2 x (1 - 6)	1 x (1 - 16) 2 x (1 - 6)	
		Flexible with ferrule	mm ²	1 x (1.5 - 10) 2 x (1.5 - 6)	1 x (1.5 - 10) 2 x (1.5 - 6)	1 x (1.5 - 10) 2 x (1.5 - 6)	1 x (1.5 - 10) 2 x (1.5 - 6)
	Solid or stranded	AWG	14 - 6	14 - 6	14 - 6	14 - 6	
Terminal screw tightening torque	Main conductors	Nm	1.8	1.8	1.8	1.8	
	Auxiliary conductors	Nm	1	1	1	1	
Main contacts							
Rated impulse withstand voltage			U_{imp}	V AC	6000	6000	6000
Overvoltage category/pollution degree				III/3	III/3	III/3	III/3
Rated operational voltage			U_e	V AC	690	690	690
Rated uninterrupted current = rated operational current			$I_u = I_e$	A	40	40	40
Rated frequency				Hz	50 - 60	50 - 60	50 - 60
Heat dissipation (3 pole at operating temperature)				W	14	23	9
Lifespan, mechanical ¹⁾			Operations	x 10 ⁶	0.1	5	5
Lifespan, electrical	100 % AC-3	Operations	x 10 ⁶	0.05	1	1	
		Operations	x 10 ⁶	—	0.03	0.03	
Maximum operating frequency			Operations/h	Ops/h	60	→ Page 7/72	
Motor switching capacity	AC-3 up to 690 V	A	40	40	40	40	
	DC-5 up to 250 V	A	40	40	40	40	
DC applications							
Breaking capacity I_{cn}	I_{cn} (250 V DC), L/R = 15 ms	kA	30	30	50	—	
	I_{cn} (125 V DC), L/R = 15 ms	kA	50	50	65	—	
Switching times in the even of a short-circuit load	Minimum command time	ms	Approx. 2	Approx. 2	Approx. 2	—	
	Opening delay	ms	Approx. 0.5	Approx. 0.5	Approx. 0.5	—	
	Total opening delay	ms	6	6	4	—	
				ZM-...-PKZ2	ZMR-...-PKZ2	ZM-...-8-PKZ2(4)	
Trip blocks							
Function				Motor protection	Motor protection	System protection	
Temperature compensation	To IEC/EN 60947, VDE 0660	°C	-5...40	-5...40	-5...40		
	Operating range	°C	-25...60	-25...60	-25...60		
Temperature compensation residual error for T > 40 °C			%/K	≤ 0.25	≤ 0.25	≤ 0.25	
Short-circuit release tolerance			%	± 20	± 20	± 20	
Setting range of overload releases			x I_u	0.6 - 1	0.6 - 1	0.6 - 1	
Short-circuit releases			x I_u	8.5 - 14	8.5 - 14	5 - 8.5	
Notes				¹⁾ With dual-frequency coil 50/60 Hz the mechanical lifespan reduces by 30%			

SE.../...PKZ, CL-PKZ

				High-capacity contact module S(EA)...
Switching times				
Closing delay		ms		9 - 30
Opening delay		ms		4 - 12
Duty factor		% DF		100
Rated making capacity at p.f. = 0.45		A		400
Rated breaking capacity at p.f. = 0.45		A		400
Magnet systems				
AC operation				
Operating range				
Pick-up voltage		$x U_s$		0.85 - 1.1
Drop-out voltage		$x U_s$		0.4 - 0.6
Power consumption				
AC pick-up rating	Pick-up	VA		190
AC consumption when closed	Holding	VA		13
DC operation				
Rated control voltage	U_s	V DC		24
Operating range				
Pick-up voltage		$x U_s$		0.85 - 1.1
Power consumption				
DC pick-up rating	Pick-up	W		150
DC consumption when closed	Holding	W		2.7
Current consumption				
Pick-up current (16 - 22 ms)		A		6.3
Holding current		mA		113
Rated operational current, enclosed/open				
AC-1	230 V	I_e	A	40
	400 V	I_e	A	40
	440 V	I_e	A	40
	500 V	I_e	A	40
	690 V	I_e	A	40
AC-3	230 V	I_e	A	40
	400 V	I_e	A	40
	440 V	I_e	A	40
	500 V	I_e	A	40
	690 V	I_e	A	40
AC-4	230 V	I_e	A	30
	400 V	I_e	A	30
	440 V	I_e	A	30
	500 V	I_e	A	28
	690 V	I_e	A	25
				Current limiters CL-PKZ2
Rated making capacity at p.f. = 0.45			A	400
Rated breaking capacity at p.f. = 0.45			A	400
AC-1 operation	Conventional thermal current	I_{th}	A	40

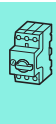

			NHI11(S)-PKZ2	NHI22(S)-PKZ2	NHI2-11S-PKZ2	AGM2-11-PKZ2	HI...S-PKZ2	HI11-S/EZ-PKZ2	ZMR... (95 - 96)	ZMR... (97 - 98)	
Auxiliary contacts											
Rated impulse withstand voltage	U_{imp}	V AC	6000	6000	6000	6000	6000	6000	6000	6000	
Overvoltage category/degree of pollution			III/3	III/3	III/3	III/3	III/3	III/3	III/3	III/3	
Rated operating voltage	U_e	V AC	500	500	500	500	500	500	500	500	
Rated operational current											
AC-15	230 - 240 V	I_e	A	6	6	6	5	6	6	1.5	1.5
	400 - 415 V	I_e	A	3	1.5	3	3	1.5	3	0.7	0.5
	440 V	I_e	A	1.5	1.5	1.5	1.5	1.5	1.5	0.5	0.3
	500 V	I_e	A	1.5	1.5	1.5	1.5	1.5	1.5	0.5	0.3
Lifespan, mechanical	Operations	$\times 10^6$	0.1	0.1	5	0.01	5	5	0.01	0.01	
Lifespan, electrical	Operations	$\times 10^6$	0.05	0.05	1	0.05	1	1	0.05	0.05	
Control circuit reliability (at $U_e = 24$ V DC, $U_{min} = 17$ V, $I_{min} = 10$ mA)	Fault probability	λ	Control circuit reliability through the entire mechanical lifespan								
Positive opening contacts as specified in EN60947-5-1 Appendix L			–	–	Yes	Yes	–	–	–	–	
Short-circuit strength without welding											
Fuseless			240 V: PKZM0-6.3 415 V: PKZM0-4 500 V: PKZM0-1.6						–	–	
Fuse			A gG/gL	10	10	10	6	10	10	10	10
Terminal capacity											
Solid or flexible with ferrule			mm ²	1 x (0.75 - 2.5) 2 x (0.75 - 2.5)							
Solid or stranded			AWG	1 x (22 - 14) 2 x (22 - 14)			22 - 14				
Safe isolation according to EN 61140											
Between auxiliary contacts and main contacts			V AC	690	690	500	–	500	500	–	–

				U-PKZ2...	U-HI20-PKZ2...	UVHI-PKZ2		
Undervoltage release								
Rated impulse withstand voltage	U_{imp}	V AC		6000	6000	6000		
Overvoltage category/pollution degree				III/3	III/3	III/3		
Terminal capacity								
Solid or flexible conductor with ferrule				mm ²	1 x (0.75 - 2.5) 2 x (0.75 - 2.5)	1 x (0.75 - 2.5) 2 x (0.75 - 2.5)	1 x (0.75 - 2.5) 2 x (0.75 - 2.5)	
Solid or stranded				AWG	22 - 14	22 - 14	22 - 14	
Rated operating voltage	U_e	V AC		24 - 600	24 - 600	24 - 600		
Rated operating voltage	U_e	V DC		24 - 125	24 - 125	24 - 125		
Drop-out voltage		$\times U_s$		0.7 - 0.35	0.7 - 0.35	0.7 - 0.35		
Power consumption								
AC voltage								
AC pick-up rating				Pick-up	VA	5	5	5
AC consumption when closed				Holding	VA	3	3	3
DC voltage								
DC pick-up rating				Pick-up	W	3	3	3
DC consumption when closed				Holding	W	3	3	3
OFF delay					ms	–	–	200
Rated operating current								
AC-15								
230 V				I_e	A	–	6	6
400 V				I_e	A	–	3	3
440 V				I_e	A	–	1.5	1.5

				A-PKZ2...
Shunt release (for power circuit-breakers)				
Rated impulse withstand voltage	U_{imp}	V AC		6000
Overvoltage category/pollution degree				III/3
Terminal capacity				
Solid or flexible conductor with ferrule		mm ²		1 x (0.75 - 2.5) 2 x (0.75 - 2.5)
Solid or stranded		AWG		22 - 14
Rated operating voltage	U_e	V AC		24 - 600
Rated operating voltage	U_e	V DC		24 - 250
Operating range				
AC voltage		x U_s		0.7 - 1.1
DC voltage		x U_s		0.7 - 1.1
Power consumption				
AC voltage				
	AC pick-up rating	Pick-up	VA	5
	AC consumption when closed	Holding	VA	3
DC voltage				
	DC pick-up rating	Pick-up	W	3
	DC consumption when closed	Holding	W	0.3



				RE-PKZ2	RS-PKZ2
Remote drives					
Rated impulse withstand voltage	U_{imp}	V AC		6000	6000
Overvoltage category/pollution degree				III/3	III/3
Rated operating voltage	U_e	V AC		380 - 440	380 - 440
Rated operating voltage	U_e	V AC/DC		24 - 240	24 - 240
Safe isolation to VDE 0106 Part 101 and Part 101 A1 between the auxiliary contacts and main circuits		V AC		500	500
Required short-time rating (30 ms)		VA/W		700	700
Control transformer short-time rating		VA		1000	1000
Short-circuit voltage		%		4.4	4.4
Closing delay		ms		≤ 30	≤ 30
Opening delay		ms		≤ 30	≤ 30
Reset time to OFF		ms		≤ 30	≤ 30
Maximum operating frequency					
	Max. operating frequency	Ops/h		60	60
Operating range					
	AC voltage	x U_s		0.85 - 1.1	0.85 - 1.1
	DC voltage	x U_s		0.85 - 1	0.85 - 1
Lifespan, electrical	Operations	x 10 ⁶		0.05	0.05
Integrated auxiliary contact (signal manual/automatic 33/34)					
	Thermal rated operational current	I_{th}	A	1.5	1.5
Rated operational current					
	AC-14	230/240 V	I_e	A	1.5
		400/415 V	I_e	A	1
		440 V	I_e	A	0.5
Terminal capacity					
	Solid or flexible conductor with ferrule		mm ²	1 x (0.75 - 2.5) 2 x (0.75 - 2.5)	1 x (0.75 - 2.5) 2 x (0.75 - 2.5)
	Solid or stranded		AWG	22 - 14	22 - 14

				BK...-PKZ2, B3.1/...-PKZ2
Supply terminal and three-phase commoning link				
Rated impulse withstand voltage	U_{imp}	V AC		6000
Overvoltage category/pollution degree				III/3
Rated operating voltage	U_e	V AC		690
Rated uninterrupted current	I_u	A		120

Motor-protective circuit-breakers and trip blocks

PKZ2/ZM... + ZMR...-PKZ2

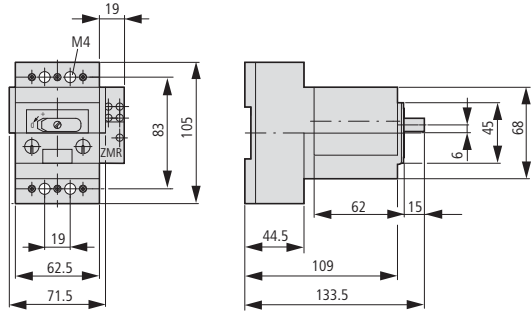

Circuit-breakers

PKZ24

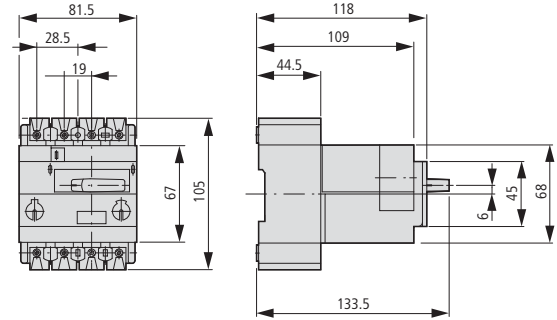

High-capacity compact starters

PKZ2/ZM.../S

PKZ2/ZM.../SE1A...

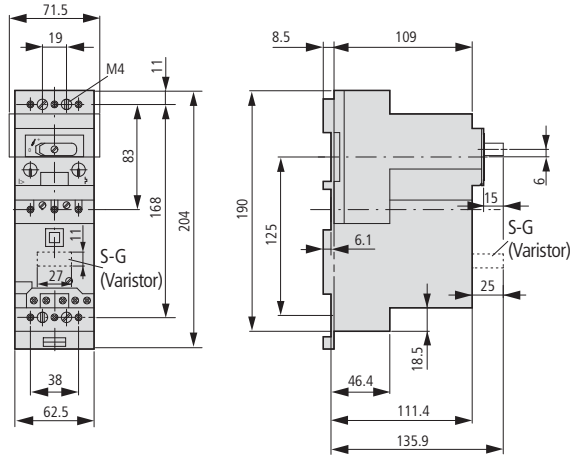

Standard auxiliary contacts for (high-capacity) compact starter

NHI...S-PKZ2

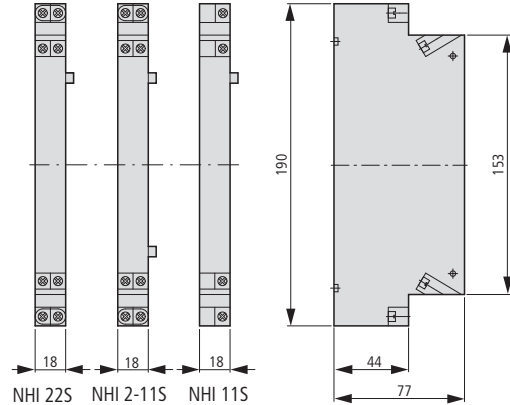

Standard auxiliary contacts

NHI...-PKZ2

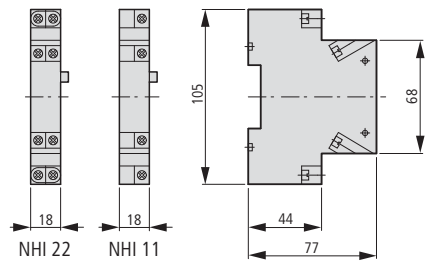

**Shunt release (for power circuit-breakers)
Undervoltage release**

U-PKZ2...
A-PKZ2...

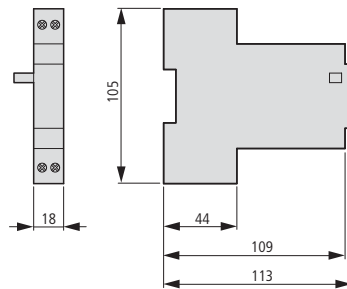

Remote drives

RE-PKZ2...
RS-PKZ2...

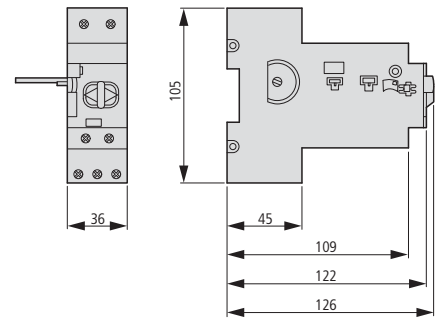

Contact modules

High-capacity contact modules

Current limiters

SE1A/11-PKZ2(...)

S-PKZ2(...)

CL-PKZ2

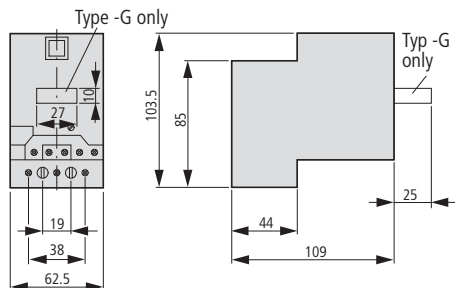

Base for separate mounting

Auxiliary contact for separate mounting

EZ-PKZ2

HI11-S/EZ-PKZ2

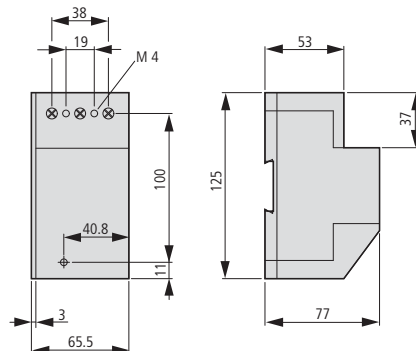

Trip-indicating auxiliary contacts

AGM2-11-PKZ2

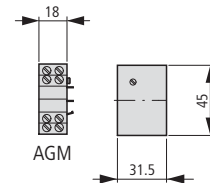

PKZ2: E-PKZ, B3...-PKZ, MV-PKZ

Insulated enclosures for surface mounting

C119EA-PKZ2

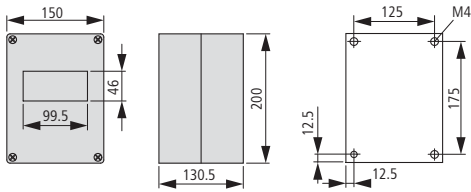

C119EB-PKZ2
C119ED-PKZ24

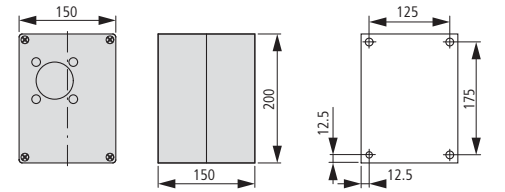

Drilling dimensions

C123EA-PKZ22

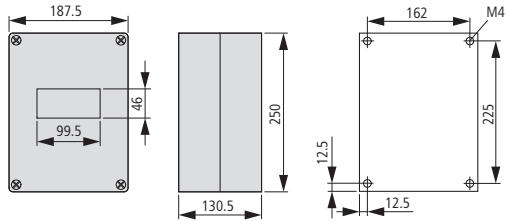

C123EB-PKZ22

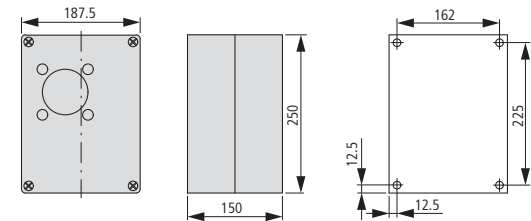

Drilling dimensions

Insulated enclosure for flush mounting

E-PKZ2

E54-PKZ2

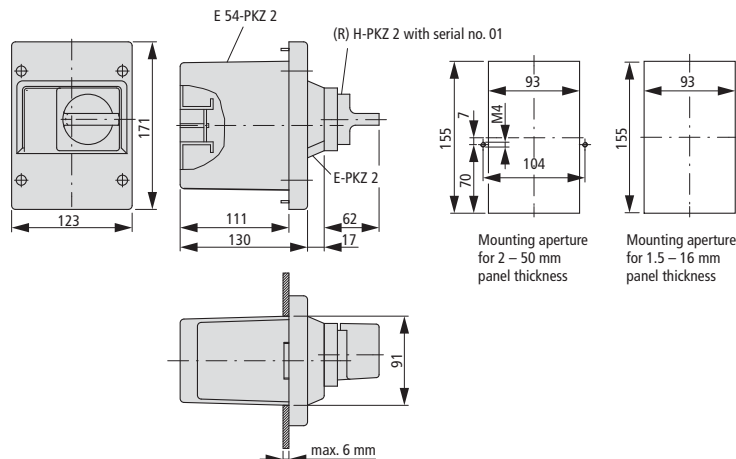

Door coupling handles

PKZ2-X...

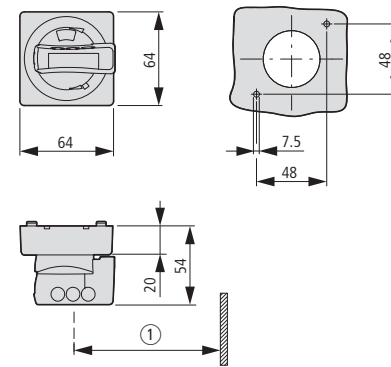

① At least 100 mm from cover hinge

Three-phase commoning links

B3.1/3-PKZ2

B3.1/2-PKZ2

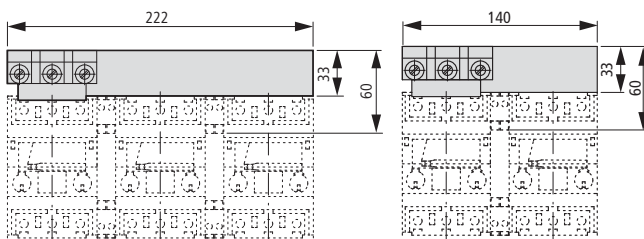

Extension terminal

BK50/3-PKZ2

Shroud for unused terminals

H-B3-PKZ2

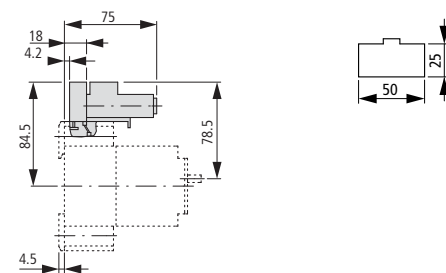

Mechanical interlock with (high-capacity) contact module

MV-PKZ2

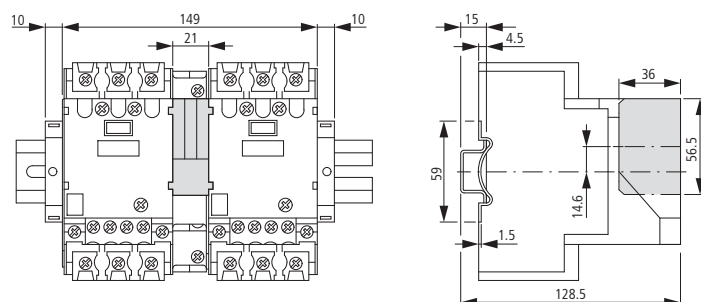

Neutral terminal for (high-capacity) contact module

N-PKZ2

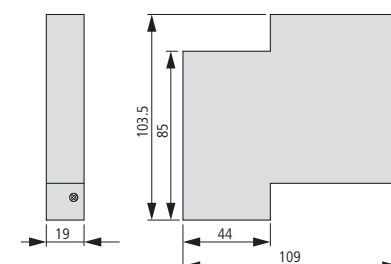

P-SOL, PKZ-SOL, SOL

Description

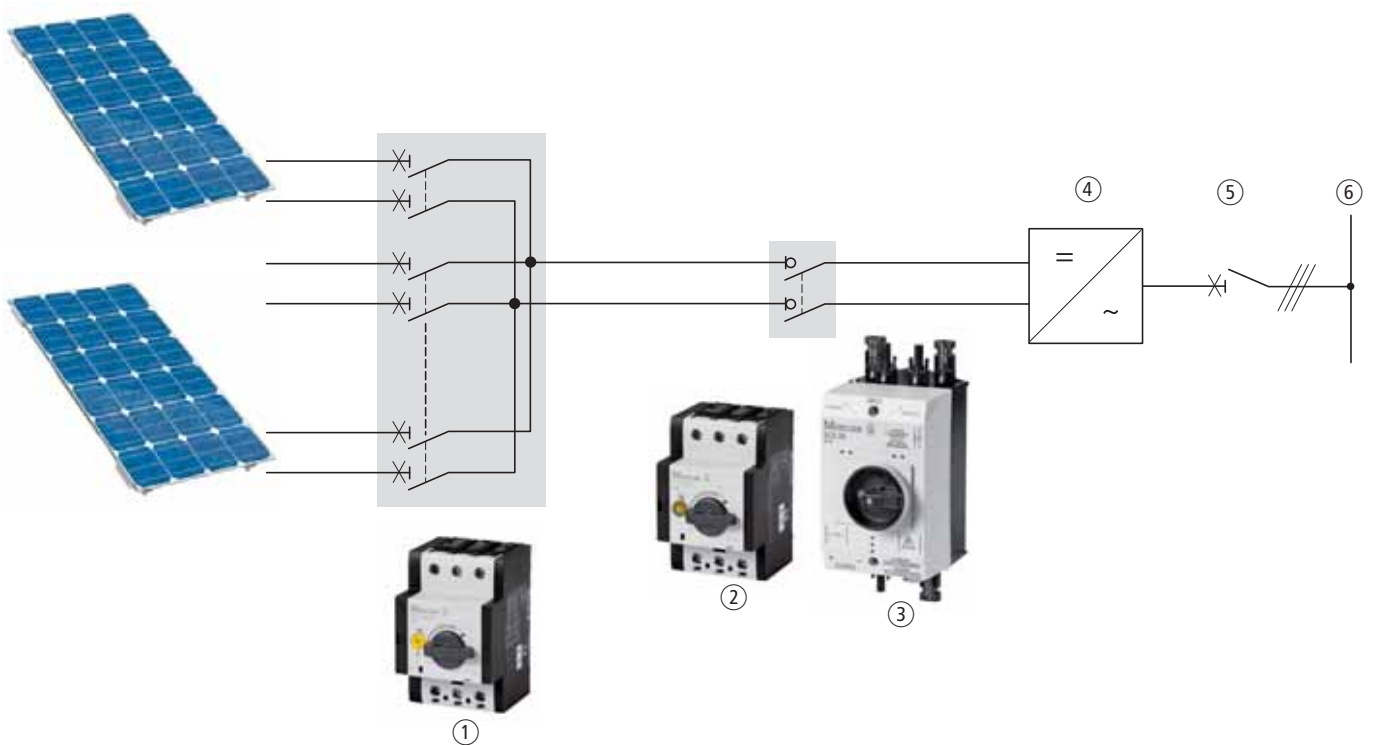

- ① DC string circuit-breaker PKZ-SOL
- ② DC switch-disconnector P-SOL
- ③ Ready-to-install DC switch-disconnector SOL
- ④ Inverter module
- ⑤ AC main switch
- ⑥ Network

Photovoltaics description

Photovoltaic systems convert sunlight directly into electrical energy using solar cells. Photovoltaics represent a renewable source of energy that can be used on private and public buildings, as well as in large-scale power stations. These systems can be independent from the power grid or can be connected to it. Photovoltaic systems that are connected to the grid feed the generated power directly into the mains network. This eliminates the need for temporary storage. These systems consist of solar cells, one or more inverters, and a protective device for automatic cutoff in the event of a grid fault. Because of this, photovoltaic systems that are connected to the grid require extremely reliable and safe individual components.

Features

DC string circuit-breakers

- Protect PV modules from fault currents, prevent (in larger systems, for instance) intact modules from feeding power back into a module with a short-circuit.
- Are ready for operation immediately after tripping and after the trip cause has been fixed.
- Open and for installation in customized generator terminal boxes.
- Tripping currents are adjustable within a wide range of limits.
- Optional shunt releases A-PKZ0 and undervoltage releases U-PKZ0 enable remote shutdown, e.g. for the fire department. Optional auxiliary contact NHI-E-PKZ0 signals switching state.
- When installed in an enclosure, suitable for voltages of up to 900 VDC.

DC switch-disconnectors



















- Required, according to standard VDE 0100-712 (June 2006), between the PV module and inverter.
- Enclosed and open (for installation in enclosure) switch-disconnectors for voltages of up to 1,000 VDC.
- Usable as a separate switching point as required in VDI Guideline VDI 6012, e.g. by de-energizing an inverter in a completely safe manner.

- Two-pole switching, making it suitable for non-earthed systems as well.
- TÜV-certified.
- Open switch-disconnectors P-SOL are designed for installation in customer-specific enclosures or inverters.
- Mounting on 35 mm top-hat rails, their terminals enable a connection to all popular cable types.
- Separate rotary handles and shaft extensions allow for flexible installation.
- An auxiliary switching block can be mounted in order to provide switching state feedback.
- A shunt release or undervoltage release is available for remote tripping.
- Switch-disconnectors SOL with enclosure are ready for installation. Models for 2 and 4 or 4 and 8 strings and for the most popular connector types, such as MC3, MC4, and metric screw connectors, allow for easy integration into various system concepts.
- Enclosure provides degree of protection IP65, making outdoor mounting possible.
- Lockable mechanism provides safety when maintenance is required.
- Pressure-equalizing element prevents the formation of condensed water, preventing failures caused by voltage sparkovers.

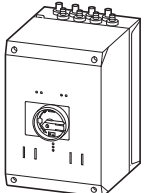
HPL07085EN

SOL

Ordering

	Inputs Number of strings	Connection type	Outputs Number of strings	Connection type	Max. rated operational current DC-21A I_e A	Part no. Article no.	Price See price list	Std. pack
DC switch-disconnector, ready-to-install								
Rated operational voltage U_e 1000 V Degree of protection IP65 Protection class 2 2 pole								
	2	MC3	1	MC3	20	SOL20/2MC3 120913		1 off 
	4	MC3	1	MC3	20	SOL20/4MC3 120914		1 off 
	2	MC4	1	MC4	20	SOL20/2MC4 120915		1 off 
	4	MC4	1	MC4	20	SOL20/4MC4 120916		1 off 
	2	Screw connector M12	1	Screw connector M16	20	SOL20/2MV 120919		1 off 
	2	MC3	1	MC3	30	SOL30/2MC3 120920		1 off 
	4	MC3	1	MC3	30	SOL30/4MC3 120921		1 off 
	2	MC4	1	MC4	30	SOL30/2MC4 120922		1 off 
	4	MC4	1	MC4	30	SOL30/4MC4 120923		1 off 
	2	Screw connector M12	1	Screw connector M16	30	SOL30/2MV 120926		1 off 
	4	MC3	1	Screw connector M20	63	SOL60/4MC3 120927		1 off 
	8	MC3	1	Screw connector M20	63	SOL60/8MC3 120928		1 off 
	4	MC4	1	Screw connector M20	63	SOL60/4MC4 120929		1 off 
	8	MC4	1	Screw connector M20	63	SOL60/8MC4 120930		1 off 
	4	Screw connector M12	1	Screw connector M20	63	SOL60/4MV 120933		1 off 

Information relevant for export to North America







NA Certification Request filed for UL and CSA

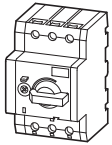

P-SOL, PKZ-SOL

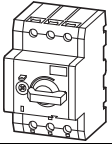
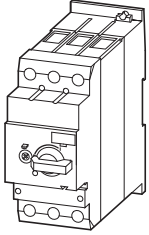
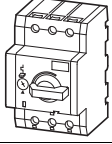
HPL07086EN

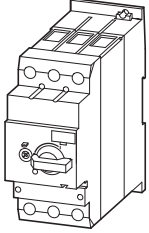
	Max. rated operational current DC-21A I_e A	Permissible solar module short-circuit currents 	Part no. Article no.	Price See price list	Std. pack
DC switch-disconnector, open					
Rated operating voltage U_e 1000 V Protection class II 2 pole					
	20		P-SOL20 120934		1 off 
	30		P-SOL30 120935		
	63		P-SOL60 120936		
DC string circuit-breakers					
Rated operating voltage U_e 900 V Protection class II 2 pole					
	12	5 - 9	PKZ-SOL12 120937		1 off 
	20	9 - 15	PKZ-SOL20 120938		
	30	15 - 22	PKZ-SOL30 120939		
	40	22 - 30	PKZ-SOL40¹⁾ 120940		
	50	29 - 38	PKZ-SOL50¹⁾ 120941		
	60	38 - 47	PKZ-SOL60¹⁾ 120942		
					

Notes

¹⁾ Availability from November 2010

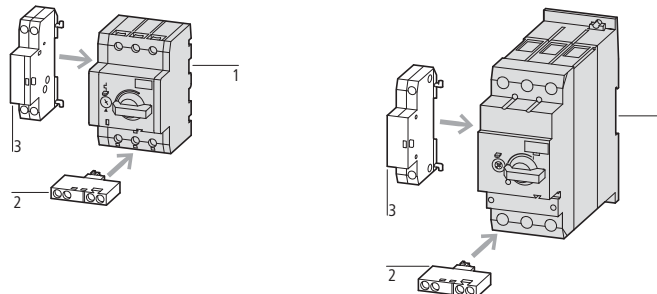

Accessories

- 2 Auxiliary contacts NHI-E
- 3 Shunt releases A-PKZ0
- 3 Undervoltage releases U-PKZ0

Page

- 7/10
- 7/29
- 7/29

Information relevant for export to North America



NA Certification Request filed for UL and CSA

P-SOL, PKZ-SOL, SOL

Engineering

P-SOL and PKZ-SOL wiring

Switch-disconnector P-SOL

Non-earthed grid

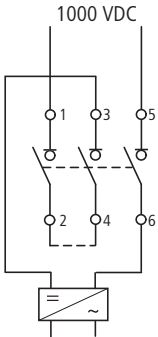

Earthed grid

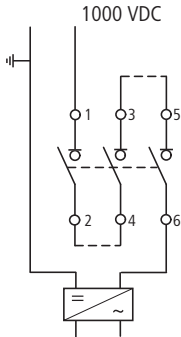

String circuit-breaker PKZ-SOL

Non-earthed grid

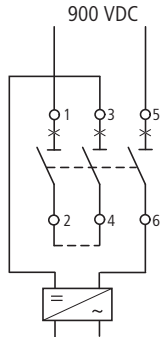

Earthed grid

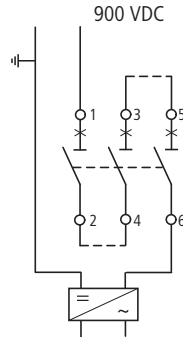

SOL internal circuit

SOL20/2MC3
SOL20/2MC4
SOL30/2MC3
SOL30/2MC4

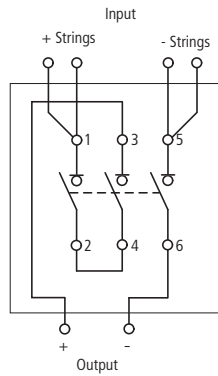

SOL20/2MV
SOL30/2MV

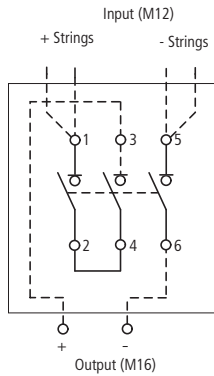

SOL20/4MC3
SOL20/4MC4
SOL30/4MC3
SOL30/4MC4

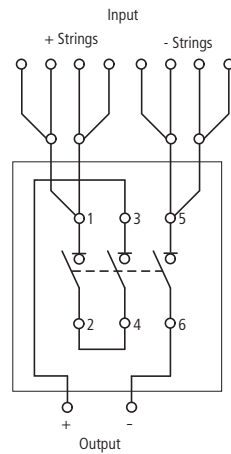

SOL60/4MC3
SOL60/4MC4

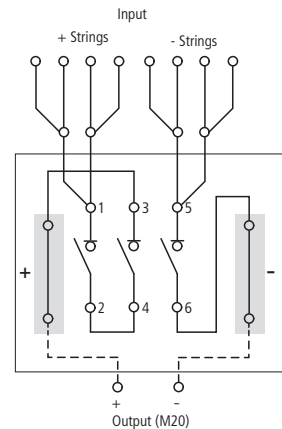

SOL60/4MV

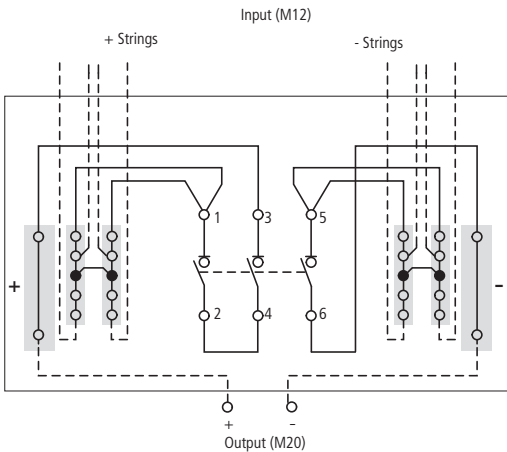

SOL60/8MC3
SOL60/8MC4

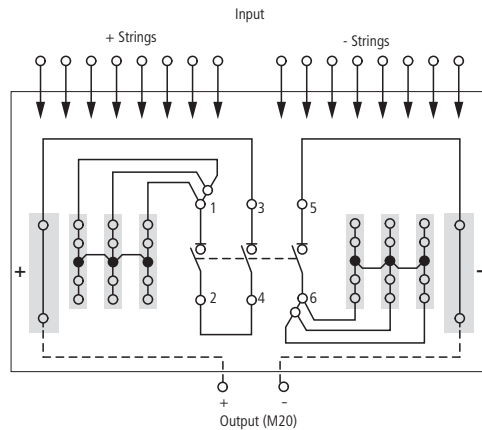

Tripping characteristics

Tripping characteristics
DC string circuit-breaker PKZ-SOL

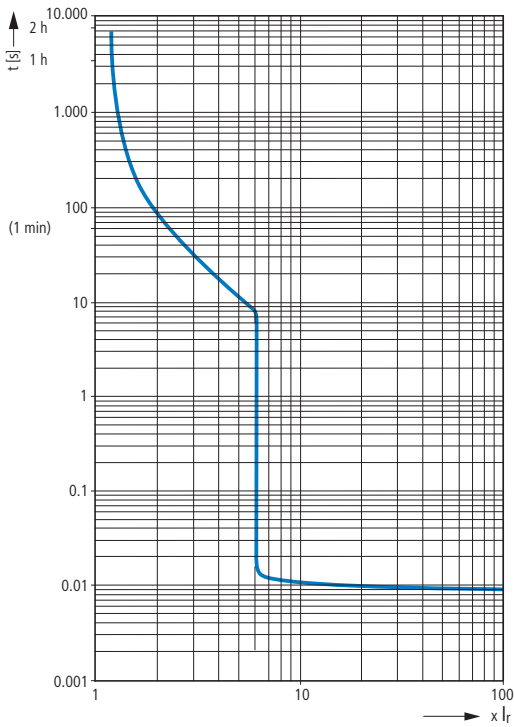

Characteristic curve set value - short-circuit current

As specified in the IEC 62548-1 draft for the protection of photovoltaic modules, the tripping current of the circuit-

breaker must lie between 1.4 and 2 times the value of the photovoltaic module's short-circuit current.

Since only the current values of the installed overload release can be plotted on the setting scale for the

circuit-breaker¹⁾, the correlation between the protective device's tripping current and the photovoltaic module's short-circuit current must be specified for each point of the scale in a suitable form.

Setting aid for string circuit-breaker PKZ-SOL

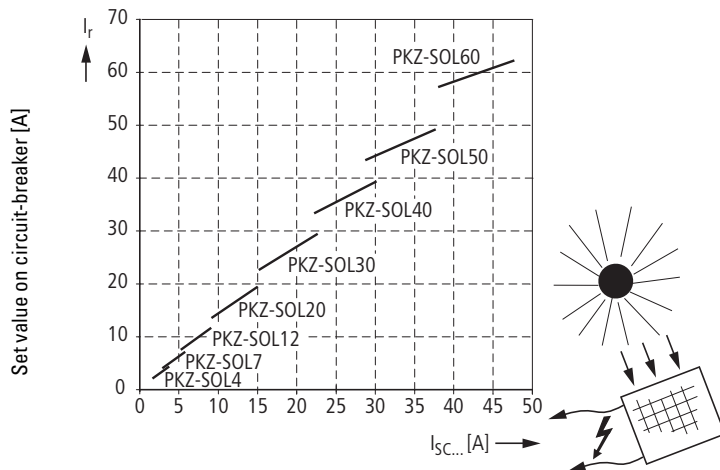

Short-circuit current in solar module [A]

¹⁾ Standard IEC/EN 60947-2 (Section 4.7.3) prohibits directly specifying the photovoltaic short-circuit current on the circuit-breaker's setting scale, meaning that only the current set value of the operating current can be plotted there.

Technical data

			SOL20	SOL30	SOL60
Rated operational current I_e at DC-21A		A	20	30	63
Number of poles			2	2	2
Rated operational voltage U_e		V DC	1000	1000	1000
Isolating characteristics			Yes	Yes	Yes
Standards			IEC/EN 60 947-3 UL 508, TÜV certificate		
Lifespan mechanical	Operations		100,000	100,000	30,000
Lifespan electrical	Operations		100,000	100,000	30,000
Max. operating frequency, mechanical		Ops/h	120	120	120
Climatic proofing			Damp heat, constant, to IEC 60 068-2-78 Damp heat, cyclic, to IEC 60 068-2-30		
Ambient temperature	min./max.	°C	-25 ... +60	-25 ... +60	-25 ... +60
Mounting position			Any	Any	Any
Degree of protection		IP	65	65	65
Dimensions					
Width		mm	100	100	160
Height		mm	215	215	305
Depth		mm	130	130	210
Weight		kg	0.42	0.42	2.2
Lockable in OFF position			Yes	Yes	Yes
Rated short-time withstand current , 1 s to EN 60947-3	I_{cw}	kA	0.24	0.36	0.72
Rated short-circuit making capacity to EN 60947-3	I_{cm}	kA	0.32	0.32	0.6
Internal resistance		mΩ	8	7	4
			P-SOL20	P-SOL30	P-SOL60
Rated operational current at DC-21A	I_e	A	20	30	63
Number of poles			2	2	2
Rated operational voltage	U_e	V DC	1000	1000	1000
Isolating characteristics			Yes	Yes	Yes
Standards			IEC/EN 60 947-3 UL 508, TÜV certificate		
Lifespan mechanical	Operations		100,000	100,000	30,000
Lifespan electrical	Operations		100,000	100,000	30,000
Max. operating frequency, mechanical		Ops/h	120	120	120
Climatic proofing			Damp heat, constant, to IEC 60 068-2-78 Damp heat, cyclic, to IEC 60 068-2-30		
Ambient temperature					
Open	min./max.	°C	-25 ... +60	-25 ... +60	-25 ... +60
Mounting position			Any	Any	Any
Dimensions					
Width		mm	58	58	55
Height		mm	93	93	140
Depth		mm	76	76	160
Mounting					
Top-hat rail			35 mm	35 mm	35 mm
Screw mounting			–	–	2 x M4 x 18 30 x 130
Weight		kg	0.32	0.32	1.25
Terminals					
Flexible with ferrule		mm ²	1 x (1-6)	1 x (1-6)	1 x (1-35)
		mm ²	2 x (1-6)	2 x (1-6)	2 x (1-35)
solid/stranded		AWG	18 - 14	18 - 14	14 - 2
Rated short-time withstand current , 1 s to EN 60947-3	I_{cw}	kA	0.24	0.36	0.72
Rated short-circuit making capacity to EN 60947-3	I_{cm}	kA	0.32	0.32	0.6
Internal resistance		mΩ	6	5	3

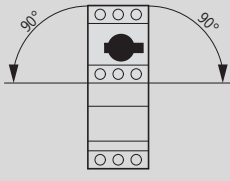
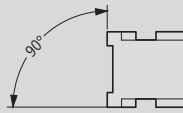

			PKZ-SOL12	PKZ-SOL20	PKZ-SOL30	PKZ-SOL40	PKZ-SOL50	PKZ-SOL60
Rated operational current at DC-21A/750VDC	I_e	A	12	20	30	40	50	63
Number of poles			2	2	2	2	2	2
Rated operational voltage	U_e	V DC	900	900	900	900	900	900
Thermal tripping			1.05 ... 1.3 x I_e					
Electromagnetic tripping			6 x I_e					
Standards			IEC/EN 60 947-2 UL 508, TÜV certificate					
Climatic proofing			Damp heat, constant, to IEC 60 068-2-78 Damp heat, cyclic, to IEC 60 068-2-30					
Ambient temperature								
Open	min./max.	°C	-25 ... +60	-25 ... +60	-25 ... +60	-25 ... +60	-25 ... +60	-25 ... +60
Mounting position			 PKZ-SOL12 to PKZ-SOL40			 PKZ-SOL40 to PKZ-SOL60		
Dimensions								
Width		mm	58	58	58	55	55	55
Height		mm	93	93	93	140	140	140
Depth		mm	76	76	76	160	160	160
Mounting								
Top-hat rail			35 mm	35 mm	35 mm	35 mm	35 mm	35 mm
Screw mounting			–	–	–	2 x M4 x 18 30 x 130	2 x M4 x 18 30 x 130	2 x M4 x 18 30 x 130
Weight		kg	0.32	0.32	0.32	1.25	1.25	1.25
Terminals								
flexible with ferrule		mm ²	1 x (1-6)	1 x (1-6)	1 x (1-6)	1 x (1-35)	1 x (1-35)	1 x (1-35)
		mm ²	2 x (1-6)	2 x (1-6)	2 x (1-6)	2 x (1-35)	2 x (1-35)	2 x (1-35)
solid/stranded		AWG	18 - 14	18 - 14	18 - 14	14 - 2	14 - 2	14 - 2
Internal resistance		mΩ	31	12	7	–	–	–

Dimensions

P-SOL20
P-SOL30
PKZ-SOL12
PKZ-SOL20
PKZ-SOL30

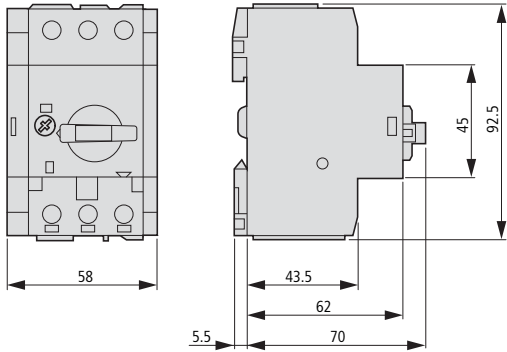

P-SOL60
PKZ-SOL40
PKZ-SOL50
PKZ-SOL60

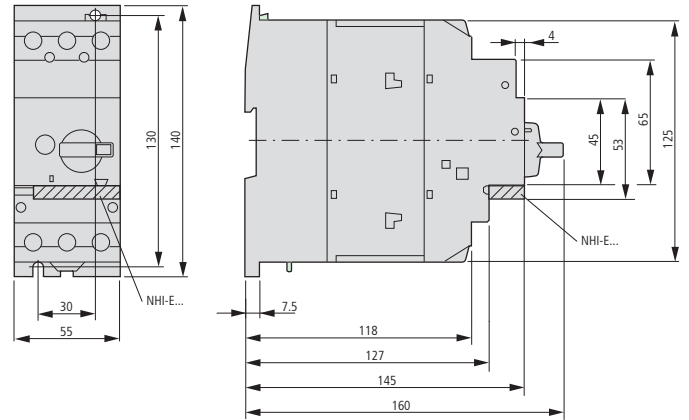

SOL20
SOL30

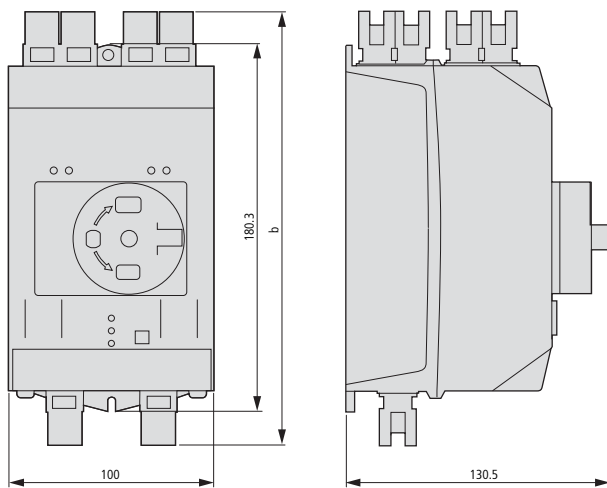

Connection type	b mm
MC3	195
MC4	234
MV	224

SOL60

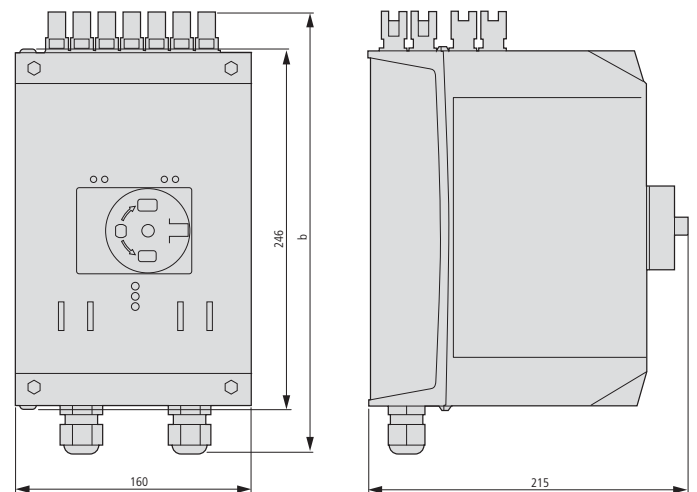

Connection type	b mm
MC3	275
MC4	314
MV	304

